

# JUMO mTRON T Measuring, Control, and Automation System

## Multichannel controller module

### Brief description

The multichannel controller module supports up to four PID controller channels (cascadable). In the standard version, two high-quality universal analog inputs for thermocouples, RTD temperature probes, resistance transmitters, resistance/potentiometers, and standard signals are available. Two digital inputs (DC 0/24 V) and two digital outputs as a relay with N/O contact (AC 230 V / 3 A) or as a logic output (DC 0/15 V) are also available as part of the standard version. Due to the three option slots (option 1, 2, and 3), the module can be extended up to four universal analog inputs, eight digital inputs, three analog outputs, or eight digital outputs.

The digitized input values/states are available in the system for further processing. The digital and the analog outputs can be actuated by the system (via the connection list or directly by the PLC) or directly by the module.

The module operates independently, even if the central processing unit fails or the higher-ranking system malfunctions. This behavior can be configured.

LEDs are used to indicate applied voltage supply, the module operating status, as well as the status of the digital inputs/outputs.

For expansion of the inputs/outputs or for service work, the module insert can be easily pulled out of the case at the front. The case including the bus PCB remains mounted on the DIN rail.

A setup program allows the user to comfortably configure and parameterize the multichannel controller module.

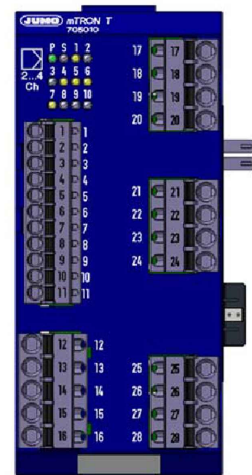

Type 705010/...

### Block diagram

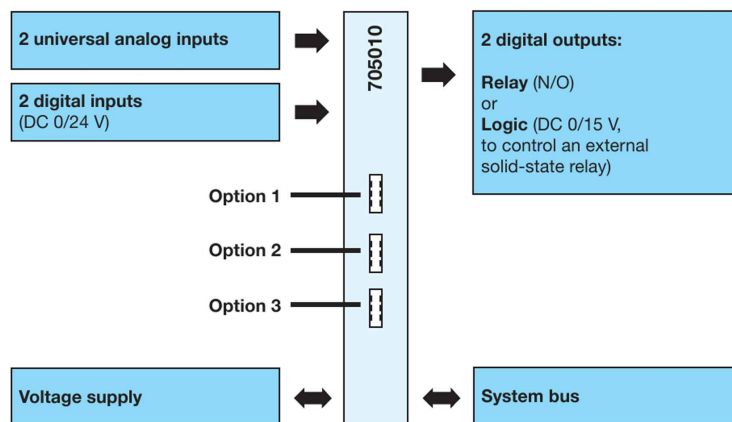

### Features

- Up to four PID controller channels each with two parameter sets and four setpoint values
- Self-optimization using the oscillation or step response method
- Independent operation
- Two universal analog inputs
- Customer-specific linearization (polynomial up to the 4th order)
- Two digital inputs DC 0/24 V
- Two digital outputs as a relay with N/O contact or a logic output
- The inputs and outputs can be extended (option)
- All analog inputs are electrically isolated from each other
- Limit value monitoring
- One counting input up to 10 kHz
- Automatic configuration after the module insert has been exchanged
- Connection of the inputs and outputs at the front
- Removable terminal strips with Push-In technology
- Quick wiring of operating voltage and system bus due to easy module connection

Approval/approval marks (see “Technical data”)

## Description

### Controller types

The controller can be configured as two-state controller, three-state controller, modulating controller, continuous controller, or continuous controller with integrated actuator controller independent of the number of channels. If the number of standard and optional inputs and outputs provided on the controller module are insufficient for the desired configuration, external inputs and outputs are available through the system bus. The cycle time of the controller module can be configured between 50 ms and 250 ms.

### Parameter sets

Two parameter sets can be saved for each of the four controller channels. Each parameter set contains 17 parameters so that separate derivative and reset times can be set for the "Heating" and "Cooling" functions. The parameter set can be changed over separately for each controller channel.

### Self-optimization

Self-optimization makes it possible for the controller to be adjusted to the control loop by a user who is not a control technology expert. During this process, the reaction of the control loop to the actuating variable is evaluated. The oscillation method is set as the standard method in the controller. The step response method can be activated in the setup program or the multifunction panel.

### Setpoint values

Up to four setpoint values can be entered for each controller channel. The setpoint value changeover is controlled by two digital signals.

### Ramp function

The ramp function is used for a continuous setpoint value change up to the ramp limit value (setpoint value input). Any analog value (e.g. actual value) available in the system can be selected as the start value. The ramp change is defined via two adjustable gradients (upward, downward). If the setpoint value changes, the new setpoint value is reached under consideration of the set gradient. Depending on the start value, the result is an upward or downward ramp. Alternatively a ramp start synchronous to a digital signal is possible. The ramp function can be stopped and canceled via digital signals.

It is possible to enter a tolerance band (symmetrically or above/below) around the setpoint value curve to monitor the actual value. If the actual value leaves the tolerance band, a digital signal is activated which can be used internally or externally.

### Limit value monitoring

For each analog input, two separate alarms (min/max alarm) can be activated; each alarm has its own limit value. Alarm type, event text, collective alarm, alarm suppression, and alarm delay are configurable.

In addition, four limit values with configurable alarm functions are available. Any analog signal can be selected as the actual value and setpoint value. The actual value monitoring depends on the set limit value and the used alarm function (monitoring band around the setpoint value, limit value above or below the setpoint value as well as independent of the setpoint value).

### Math and logic function

The optional math and logic function (extra code of base unit) can be used to link analog or binary values. Up to four freely configurable math or logic formulas can be entered with the setup program. The results are available in the controller module for various functions or can be made available at the outputs.

### Analog inputs

The maximum four analog inputs are universal measuring inputs for RTD temperature probes, thermocouples, resistance transmitters, resistance/potentiometers, and standard signals (current, voltage). Linearizations for over 20 common measuring probes (RTD temperature probes, thermocouples) are stored. A measured value offset or a fine adjustment can be carried out to compensate for plant-specific deviations. Due to the measuring circuit monitoring, a measuring range that is too high or too low, probe/cable break, and probe/cable short circuit are detected – depending on the measuring element type – so that the system is switched to an operational safe status in the event of an error.

### Customer-specific linearization

A customer-specific linearization is also possible. Programming is carried out through a formula (polynomial up to the 4th order) using the setup program.

### Analog outputs

The maximum three analog outputs are freely scalable (current, voltage). They can be used to make available controller outputs, setpoint values, math results, signals of the analog inputs (e.g. actual value), and values from the system bus. The output behavior in case of an error is selectable from available options (e.g. behavior according to NAMUR recommendation NE 43).

### Digital inputs

The signals of the up to eight digital inputs (DC 0/24 V) can be used to initiate various internal functions such as changeover of the parameter set, start of self-optimization, or acknowledgement of a limit value exceedance.

### Linking of digital signals

External and internal digital signals (e.g. logic results) can be OR-linked. Four logic links of up to four digital signals are possible. The results are also available to control internal functions or they can be made available at the digital outputs.

### Digital outputs

The up to eight digital outputs can be used to provide digital signals such as controller outputs, signals of the limit value monitoring, logic results, signals of the digital inputs, and values from the system bus. In addition to the two standard outputs (relay or logic), further outputs can be realized via the option slots (relay, solid-state relay, open-collector output).

### Counter

The controller module is equipped with a counter which is solidly connected to the first digital input and counts all low-high edges of the input signal. The counter reading is available in the base unit. The counter runs endlessly in the "Counting" operating mode. The counter starts with zero again after reaching the maximum counting value (0xFFFF). In the "Filling" operating mode the counter is started via a digital signal and generates a switch-off signal when the adjustable switch-off limit is reached.

### Operation

The controller module is operated with the multifunction panel. Furthermore, specific values can be changed and functions can be activated via the PLC or the Modbus interface (base unit).

## Controller parameters

All the parameters and their meanings are included in the table. Some parameters may be missing or do not apply for a particular type of controller. Two parameter sets can be stored for each of the four possible controller channels to handle special applications.

Parameters	Value range	Factory set	Meaning
Proportional band Xp1	0 to 9999 digit	0 digit	Size of the proportional band.
Proportional band Xp2	0 to 9999 digit	0 digit	The controller structure is not effective with 0 (behavior identical to limit value monitoring)! For a continuous controller, Xp1/2 must be > 0.
Derivative time Tv1	0 to 9999 s	80 s	Influences the differential component of the controller output signal.
Derivative time Tv2	0 to 9999 s	80 s	
Reset time Tn1	0 to 9999 s	350 s	Influences the integral component of the controller output signal.
Reset time Tn2	0 to 9999 s	350 s	
Switching period Cy1	0 to 999.9 s	20.0 s	When using a switched output, the switching period should be chosen so that, on the one hand the energy flow to the process is almost continuous, and on the other hand the switching elements are not overloaded.
Switching period Cy2	0 to 999.9 s	20.0 s	
Contact spacing Xsh	0 to 999.9 digit	0.0 digit	Spacing between the two control contacts for a three-state controller, modulating controller, and continuous controller with integrated actuator controller.
Switching differential Xd1	0 to 999.9 digit	1.0 digit	Switching differential for a switching controller with proportional range Xp = 0.
Switching differential Xd2	0 to 999.9 digit	1.0 digit	
Actuator time TT	5 to 3000 s	60 s	Applied run time range of the control valve (actuator) of the modulating controller and continuous controller with integrated actuator controller.
Working point Y0	-100 to 100 %	0 %	Output value for P and PD controllers (for x = w is y = Y0).
Output value limits Y1	0 to 100 %	100 %	Maximum output value limits (only effective when Xp > 0).
Output value limits Y2	-100 to +100 %	-100 %	Minimum output value limits (only effective when Xp > 0).
Minimum relay ON period Tk1	0.00 to 60.00 s	0.00 s	Limitation of the switching frequency for switching outputs.
Minimum relay ON period Tk2	0.00 to 60.00 s	0.00 s	

## Technical data

### Analog inputs

#### General information

Number (standard version)	2 (input 1 and 2)
Optional number (option slot 1 to 3)	2 (input 3 and 4)
A/D converter	Dynamic resolution up to 16 bit

#### Thermocouples

Designation	Standard	Measuring range	Measuring accuracy <sup>a</sup>	Ambient temperature influence
Fe-CuNi "L"		-200 to +900 °C	≤ 0.1 % from -100 °C	300 ppm/K
Fe-CuNi "J"	DIN EN 60584	-200 to +1200 °C	≤ 0.1 % from -100 °C	300 ppm/K
Cu-CuNi "U"		-200 to +600 °C	≤ 0.1 % from -130 °C	300 ppm/K
Cu-CuNi "T"	DIN EN 60584	-200 to +400 °C	≤ 0.1 % from -150 °C	300 ppm/K
NiCr-Ni "K"	DIN EN 60584	-200 to +1372 °C	≤ 0.1 % from -80 °C	300 ppm/K
NiCr-CuNi "E"	DIN EN 60584	-200 to +1000 °C	≤ 0.1 % from -80 °C	300 ppm/K
NiCrSi-NiSi "N"	DIN EN 60584	-100 to +1300 °C	≤ 0.1 % from -80 °C	300 ppm/K
Pt10Rh-Pt "S"	DIN EN 60584	-50 to 1768 °C	≤ 0.15 % from 20 °C	300 ppm/K
Pt13Rh-Pt "R"	DIN EN 60584	-50 to 1768 °C	≤ 0.15 % from 20 °C	300 ppm/K
Pt30Rh-Pt6Rh "B"	DIN EN 60584	0 to 1820 °C	≤ 0.15 % from 400 °C	300 ppm/K
W5Re-W26Re "C"		0 to 2320 °C	≤ 0.15 % from 500 °C	300 ppm/K
W3Re-W25Re "D"		0 to 2495 °C	≤ 0.15 % from 500 °C	300 ppm/K
W3Re-W26Re		0 to 2400 °C	≤ 0.15 % from 500 °C	300 ppm/K
Chromel-Copel	GOST 8.585-2001	-200 to +800 °C	≤ 0.15 % from -80 °C	300 ppm/K
Chromel-Alumel	GOST 8.585-2001	-200 to +1372 °C	≤ 0.1 % from -80 °C	300 ppm/K
PLII (Platinel II)		0 to 1395 °C	≤ 0.1 % from -80 °C	300 ppm/K
Linear		0 to 75 mV	≤ 0.1 %	300 ppm/K
Cold junction		Pt100 internal		
Cold junction accuracy		± 1 K		

<sup>a</sup> The accuracy values refer to the maximum measuring range. Smaller measuring ranges lead to reduced linearization accuracy.

#### RTD temperature probe

Designation	Standard	Measuring range	Measuring accuracy <sup>a</sup>	Ambient temperature influence
Pt100 2-wire circuit 3-wire/4-wire circuit	DIN EN 60751	-200 to +850 °C	≤ 0.15 % ≤ 0.05 %	50 ppm/K
Pt500 2-wire circuit 3-wire/4-wire circuit	DIN EN 60751	-200 to +850 °C	≤ 0.30 % ≤ 0.15 %	50 ppm/K
Pt1000 2-wire circuit 3-wire/4-wire circuit	DIN EN 60751	-200 to +850 °C	≤ 0.20 % ≤ 0.08 %	50 ppm/K
Ni100 2-wire circuit 3-wire/4-wire circuit	DIN 43760	-60 to +250 °C	≤ 0.36 % ≤ 0.24 %	50 ppm/K
Pt100 2-wire circuit 3-wire/4-wire circuit	JIS 1604	-200 to +650 °C	≤ 0.20 % ≤ 0.06 %	50 ppm/K

Designation	Standard	Measuring range	Measuring accuracy <sup>a</sup>	Ambient temperature influence
Pt50 2-wire circuit 3-wire/4-wire circuit	GOST 6651-94	-200 to +1100 °C	≤ 0.30 % ≤ 0.06 %	50 ppm/K
Pt100 2-wire circuit 3-wire/4-wire circuit	GOST 6651-94	-200 to +850 °C	≤ 0.15 % ≤ 0.05 %	50 ppm/K
Cu50 2-wire circuit 3-wire/4-wire circuit	GOST 6651-94	-50 to +200 °C	≤ 0.80 % ≤ 0.60 %	200 ppm/K
Cu100 2-wire circuit 3-wire/4-wire circuit	GOST 6651-94	-50 to +200 °C	≤ 0.80 % ≤ 0.50 %	200 ppm/K
KTY11-6 2-wire circuit 3-wire/4-wire circuit		-50 to +150 °C	≤ 1 % ≤ 0.24 %	50 ppm/K
Sensor lead resistance		Max. 30 Ω per lead for 3-wire and 4-wire circuit Max. 10 Ω per lead for 2-wire circuit		
Measuring current		Pt100 approx. 250 μA, Pt500, and Pt1000 approx. 100 μA; not constant		
Lead compensation		Not required for 3-wire and 4-wire circuit. For a 2-wire circuit, lead compensation can be set in the software by correcting the actual value.		

<sup>a</sup> The accuracy values refer to the maximum measuring range. Smaller measuring ranges lead to reduced linearization accuracy.

### Standard signals

Designation	Measuring range	Measuring accuracy <sup>a</sup>	Ambient temperature influence
Voltage Input resistance $R_E > 500 \text{ k}\Omega$ Input resistance $R_E > 100 \text{ k}\Omega$	DC 0(2) to 10 V DC 0 to 1 V	≤ 0.05 %	100 ppm/K
Current (voltage drop ≤ 2 V)	DC 0(4) to 20 mA	≤ 0.05 %	100 ppm/K
Heater current	AC 0 to 50 mA	≤ 1 %	100 ppm/K
Resistance transmitter	100 Ω to 4 kΩ	± 4 Ω	100 ppm/K
Resistance/potentiometer	100 Ω to 4 kΩ	± 4 Ω	100 ppm/K

<sup>a</sup> The accuracy values refer to the maximum measuring range. Smaller measuring ranges lead to reduced linearization accuracy.

## Measuring circuit monitoring

In the event of an error the outputs move to a defined status.

Measuring element	Underrange	Overrange	Probe or lead short circuit	Probe or lead break circuit
Thermocouple	Is detected	Is detected	Is not detected	Is detected
RTD temperature probe	Is detected	Is detected	Is detected	Is detected
Voltage				
2 to 10 V	Is detected	Is detected	Is detected	Is detected
0 to 10 V	Is detected	Is detected	Is not detected	Is not detected
0 to 1 V	Is detected	Is detected	Is not detected	Is not detected
Current				
4 to 20 mA	Is detected	Is detected	Is detected	Is detected
0 to 20 mA	Is not detected	Is detected	Is not detected	Is not detected
Heater current	Is detected	Is detected	Is not detected	Is not detected
Resistance transmitter	Is detected	Is detected	Is not detected	Is detected
Resistance/potentiometer	Is detected	Is detected	Is detected	Is detected

## Digital inputs

Number (standard version)	2 (input 1 and 2)
Optional number (option slot 1 to 3)	6 (input 5 to 10)
Input signal	DC 0/24 V (Input 1: Counting input up to 10 kHz) (PLC level; logical "0" = -3 to +5 V; logical "1" = +15 to +30 V)

## Analog outputs

### Per optional board (option slot 1 to 3)

1 analog output (configurable) (Output 1 to 3)	Load resistance $R_{Load}$	Accuracy	Ambient temperature influence
Voltage DC 0(2) to 10 V	$\geq 500 \Omega$	$\pm 0.25 \%$	$\pm 150 \text{ ppm/K}$
Current DC 0(4) to 20 mA	$\leq 500 \Omega$	$\pm 0.25 \%$	$\pm 150 \text{ ppm/K}$

Selectable output behavior in case of an error according to NAMUR recommendation NE 43 (for signal type 2 to 10 V and 4 to 20 mA).

## Digital outputs

### Standard version

2 relay outputs (N/O) Switching capacity	3A at AC 230V resistive load 3A at DC 30V resistive load
Contact life	150,000 operations at rated load / 350,000 operations at 1 A
or	
2 logic outputs (to control external solid-state relays)	
Output signal	DC 0/15 V
Current	Max. 25 mA per output
(Output 3 and 4)	

**Per optional board (option slot 1 to 3)**

1 relay output (changeover contact) Output 5, 7, and 9) Switching capacity Contact life	3A at AC 230V resistive load 3A at DC 30V resistive load 350,000 operations at rated load / 750,000 operations at 1 A
2 relay outputs (N/O contacts with common pole) (Output 5 to 10) Switching capacity Contact life	3A at AC 230V resistive load 3A at DC 30V resistive load 350,000 operations at rated load / 900,000 operations at 1 A
1 solid-state relay (Output 5, 7, and 9) Switching capacity Protection circuitry	1 A at 230 V Varistor
2 open-collector outputs (Output 5 to 10) Status logical "0" (transistor inhibited): Allowable voltage via switching transistor Maximum reverse current Status logical "1" (transistor switched): Maximum voltage via switching transistor Maximum current	Min. 5 V, max. 30 V 0.1 mA $\leq 1.6$ V 50 mA

**Controller**

Controller types	Two-state controller, three-state controller, modulating controller, continuous controller, continuous controller with integrated actuator controller
Controller structures	P, PD, PI, PID
Sampling rate	50 ms, 100 ms, 150 ms, 200 ms, or 250 ms

## Electrical data

Voltage supply	
Connection	Lateral (feed via base unit or router module)
Voltage input	DC 24 V +25/-20 %
Residual ripple	5 %
Current consumption	Max. 300 mA (at DC 19.2 V)
Power consumption	Max. 6 W
Inputs and outputs (terminals 1 to 28)	
Connection	At the front (removable terminal strips with Push-In technology)
Conductor cross section on terminals 1 to 11	
Wire or strand without ferrule	Min. 0.14 mm <sup>2</sup> , max. 1.5 mm <sup>2</sup>
Strand with ferrule	Without plastic collar: Min. 0.25 mm <sup>2</sup> , max. 1.5 mm <sup>2</sup> With plastic collar: Min. 0.25 mm <sup>2</sup> , max. 0.5 mm <sup>2</sup>
Stripping length on terminals 1 to 11	9 mm
Conductor cross section on terminals 12 to 28	
Wire or strand without ferrule	Min. 0.5 mm <sup>2</sup> , max. 2.5 mm <sup>2</sup>
Strand with ferrule	Min. 0.5 mm <sup>2</sup> , max. 2.5 mm <sup>2</sup>
2 x strand with twin ferrule with plastic collar	Min. 0.5 mm <sup>2</sup> , max. 1.5 mm <sup>2</sup> (both strands with the same cross section)
Stripping length on terminals 12 to 28	10 mm
Electrical safety	Acc. to EN 61010-1 Overvoltage category III, pollution degree 2
Electromagnetic compatibility	Acc. to EN 61326-1
Interference emission	Class A – only for industrial use –
Interference immunity	Industrial requirements

## Case and ambient conditions

Case type	Plastic case for DIN rail mounting in the control cabinet (indoor use); DIN rail acc. to DIN EN 60715, 35 mm x 7.5 mm x 1 mm
Dimensions (W x H x D)	45 mm x 103.6 mm x 101.5 mm (without connection elements)
Weight (fully equipped)	Approx. 250 g
Protection type	IP20, acc. to DIN EN 60529
Ambient temperature range	-20 to +55 °C
Storage temperature range	-40 to +70 °C
Resistance to climatic conditions	Relative humidity ≤ 90 % annual average without condensation (climatic class 3K3 acc. to DIN EN 60721-3-3 with extended temperature and humidity range)
Site altitude	Up to 2000 m above sea level
Mechanical ambient conditions <sup>a</sup>	Classification acc. to DIN EN 60721-3-3, table 6, class 3M2

<sup>a</sup> Test conditions are listed in the System Descripion B 705000.8.

## Approval/approval marks

Approval mark	Testing agency	Certificate/certification number	Inspection basis	Valid for
c UL us	Underwriters Laboratories	E201387	UL 61010-1 (3. Ed.), CAN/CSA-22.2 No. 61010-1 (3. Ed.)	all types

## Display and connection elements

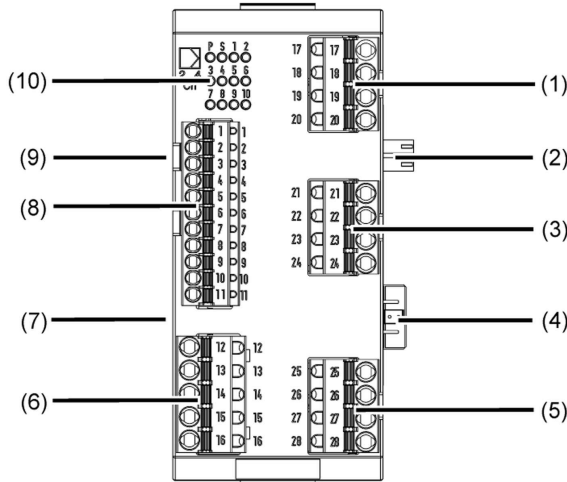

- (1) Option slot 1:
  - Analog input 3
  - Digital inputs/outputs 5, 6
  - Analog output 1
- (2) Voltage supply Out, DC 24 V
- (3) Option slot 2:
  - Analog input 4
  - Digital inputs/outputs 7, 8
  - Analog output 2
- (4) Side system bus Out
- (5) Option slot 3:
  - Digital inputs/outputs 9, 10
  - Analog output 3
- (6) Digital outputs 3, 4
- (7) Side system bus In
- (8) Analog inputs 1, 2 and digital inputs 1, 2
- (9) Voltage supply In, DC 24 V
- (10) Status displays (LED):
  - P = Voltage supply and operating mode
  - S = Status
  - 1 to 10 = Digital inputs/outputs (LED is lit: Active)

## Electrical isolation

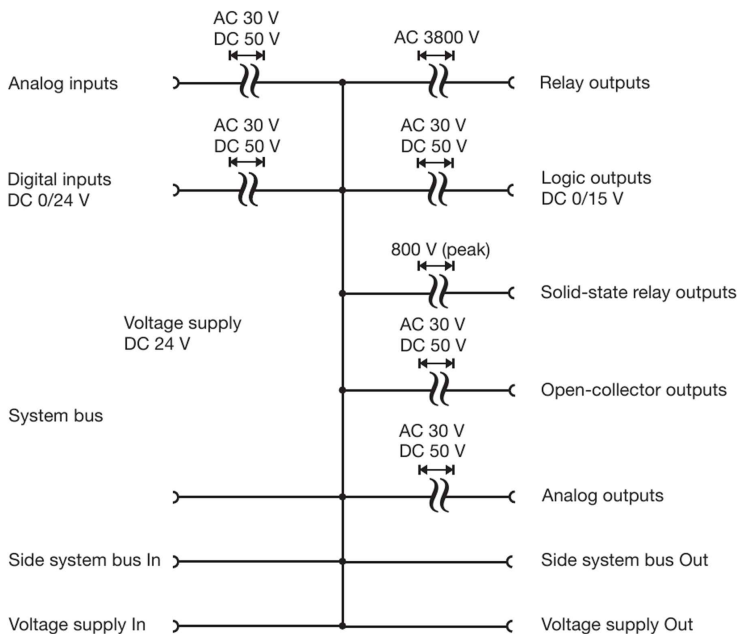

- Relay outputs: Electrically isolated from each other
- Logic outputs DC 0/15 V: Electrically isolated from each other
- Solid-state relay outputs: Electrically isolated from each other
- Open-collector outputs: Outputs of various option slots electrically isolated from each other
- Analog outputs: Electrically isolated from each other
- Digital inputs DC 0/24 V: Inputs of different boards (main board, option slots) electrically isolated from each other
- Analog inputs: Electrically isolated from each other

## Connection diagram

The connection diagram included in the data sheet provides initial information about the connection options. Only use the installation instructions or the operating manual for the electrical connection. The know-how and the correct technical implementation of the safety warnings/instructions contained in these documents are the prerequisite for the installation, electrical connection, and initial start as well as for the safety during operation.

### Analog inputs

Input 1, 2: Standard version; input 3, 4: Option

Connection	Input	Terminals	Symbol and terminal designation
Thermocouple	1 2 3 4	2 and 3 6 and 7 18 and 19 22 and 23	
RTD temperature probe 2-wire circuit	1 2 3 4	2 and 4 6 and 8 18 and 20 22 and 24	
RTD temperature probe 3-wire circuit	1 2 3 4	2 to 4 6 to 8 18 to 20 22 to 24	
RTD temperature probe 4-wire circuit	1 2 3 4	1 to 4 5 to 8 17 to 20 21 to 24	
Voltage DC 0(2) to 10 V	1 2 3 4	1 and 2 5 and 6 17 and 18 21 and 22	
Voltage DC 0 to 1 V	1 2 3 4	2 and 3 6 and 7 18 and 19 22 and 23	
Current DC 0(4) to 20 mA, Heater current AC 0 to 50 mA	1 2 3 4	3 and 4 7 and 8 19 and 20 23 and 24	
Resistance transmitter A = Start E = End S = Slider	1 2 3 4	2 to 4 6 to 8 18 to 20 22 to 24	
Resistance/potentiometer 2-wire circuit	1 2 3 4	2 and 4 6 and 8 18 and 20 22 and 24	
Resistance/potentiometer 3-wire circuit	1 2 3 4	2 to 4 6 to 8 18 to 20 22 to 24	

Connection	Input	Terminals	Symbol and terminal designation
Resistance/potentiometer 4-wire circuit	1 2 3 4	1 to 4 5 to 8 17 to 20 21 to 24	

## Digital inputs

Connection	Input	Terminals	Symbol and terminal designation
Digital input DC 0/24 V, standard version (Input 1: Counting input)	1 2	9 and 11 10 and 11	
Digital input DC 0/24 V, optional  Terminals 19 and 20, 23 and 24 as well as 27 and 28 are internally linked.	5 6 7 8 9 10	17 and 19 18 and 20 21 and 23 22 and 24 25 and 27 26 and 28	

## Analog outputs

Connection	Output	Terminals	Symbol and terminal designation
Analog output DC 0/2 to 10 V or DC 0/4 to 20 mA (configurable), optional	1 2 3	18 and 19 22 and 23 26 and 27	

## Digital outputs

### Standard version

In the standard version the controller module is equipped with relay or logic outputs (see "Order details").

Connection	Output	Terminals	Symbol and terminal designation
Relay output (N/O)	3 4	12 and 13 15 and 16	
Logic output DC 0/15 V	3 4	12 and 13 15 and 16	

The digital output numbering starts with 3. This allows the direct assignment to the LEDs of the digital outputs (LED 3 to 10).

**Optional**

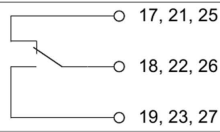
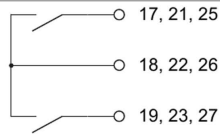
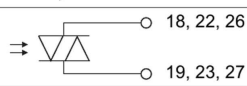
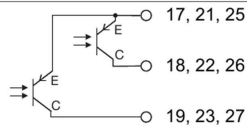
Connection	Output	Terminals	Symbol and terminal designation
Relay output (changeover contact)	5 7 9	17 to 19 21 to 23 25 to 27	
Relay output (N/O)	5 6 7 8 9 10	17 and 18 18 and 19 21 and 22 22 and 23 25 and 26 26 and 27	
Solid-state relay	5 7 9	18 and 19 22 and 23 26 and 27	
Open-collector output C = Collector E = Emitter	5 6 7 8 9 10	17 and 18 17 and 19 21 and 22 21 and 23 25 and 26 25 and 27	

## Dimensions

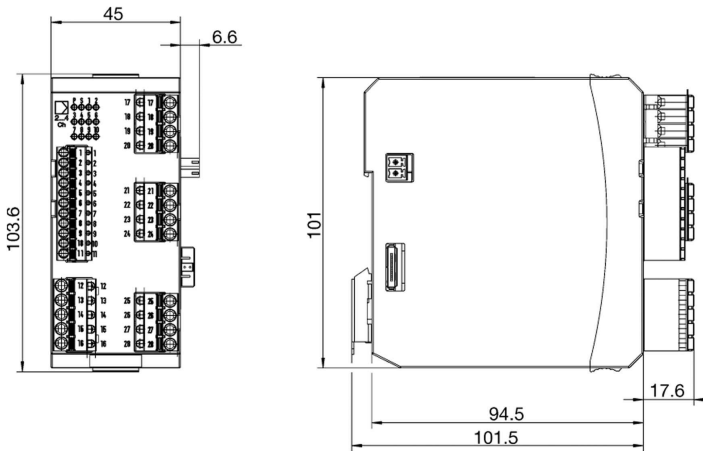

## Module overview

### Base units

- Central processing unit  
Data sheet 705001

### Input/output modules

- Multichannel controller module  
Data sheet 705010
- Relay module 4-channel  
Data sheet 705015
- Analog input module 4-channel  
Data sheet 705020
- Analog input module 8-channel  
Data sheet 705021
- Digital input/output module 12-channel  
Data sheet 705030

### Special modules

- Router module  
Data sheet 705040

### Operating, visualization, recording

- Multifunction panel 840  
Data sheet 705060

### Power supply units

- 705090/05-33  
Data sheet 705090
- 705090/10-33  
Data sheet 705090

## Order details

<b>(1) Basic type</b>	
705010	Multichannel controller module, 2x universal input, 2x digital input, 2x relay output
<b>(2) Basic type extension</b>	
1	2 relays (N/O contact)
2	2 logic outputs 0/15 V
<b>(3) Version</b>	
8	With factory settings
<b>(4) Option slot 1</b>	
0	Not used
1	Analog input 2
2	Relay (changeover contact)
3	2 relays (N/O contacts with common pole)
4	Analog output
5	2 digital inputs
6	Solid-state relay 1 A
7	2 open-collector outputs
<b>(5) Option slot 2</b>	
0	Not used
1	Analog input 2
2	Relay (changeover contact)
3	2 relays (N/O contacts with common pole)
4	Analog output
5	2 digital inputs
6	Solid-state relay 1 A
7	2 open-collector outputs
<b>(6) Option slot 3</b>	
0	Not used
2	Relay (changeover contact)
3	2 relays (N/O contacts with common pole)
4	Analog output
5	2 digital inputs
6	Solid-state relay 1 A
7	2 open-collector outputs
<b>(7) Voltage supply</b>	
36	DC 24 V +25/-20 %

**Order code**      (1)      (2)      (3)      (4)      (5)      (6)      (7)  
 [ ] / [ ] [ ] - [ ] [ ] [ ] - [ ]  
**Order example**      705010 / 1 8 - 0 0 0 - 36

## Scope of delivery

1 multichannel controller module in the ordered version
1 Installation instructions B 705010.4

## Accessories

Article	Part no.
Modules for option slots (expansion boards):	
Analog input	00569497
Relay (changeover contact)	00569498
2 relays (N/O contacts with common pole)	00569499
Analog output	00569500
2 digital inputs	00569501
Solid-state relay 1 A	00569502
2 open-collector outputs	00569503

## General accessories

Article	Part no.
JUMO mTRON T system manual, English	00575577
MiniDVD with setup program (full version), programming software CODESYS V3, and detailed documentation; incl. USB cable	00569494
PC Evaluation Software PCA3000	00431882
Release automatic print for PC Evaluation Software PCA3000	00505548
PCA Communication Software PCC	00431879
Plant Visualization Software JUMO SVS3000: See data sheet 700755	-
USB cable A-plug mini-B-plug 3 m	00506265