

JUMO TYA 202 Thyristor Power Controller in a three-phase economy circuit For the continuous control of ohmic-inductive loads

The JUMO TYA 202 represents a consistent further development of the JUMO power controller technology and switches ohmic-inductive loads in a rotary current economic circuit. The micro-processor controlled power controller displays all parameters in a back-lighted LCD display and is operated using the 4 keys on the front.

Thyristor power controllers are employed where larger resistive and ohmic-inductive loads have to be switched, e.g. in industrial kiln construction and in plastics processing.

The Thyristor power controller comprises two SCRs connected in anti-parallel, the insulated cooling body and the control electronics.

Thyristor power controllers up to a load current of 32 A can either be clipped onto a 35 mm mounting rail or fitted to the wall with a mounting plate.

Units with a load current greater than 32A have to be fitted to the wall.

The TYA 202 works in burst-firing mode.

In burst-firing mode, the phase angle can be cut back for the first half-cycle, for driving transformer loads.

Available subordinate controls are U, U², I, I² and P control.

Use of a subordinate control ensures that fluctuations in the supply voltage do not affect the control loop during the control process.

It is possible to preset a base load.

To avoid high starting or inrush currents, a soft start function is available.

The Thyristor power controllers comply with the operating conditions according to DIN EN 50178.

Grounding is required in conformity with the regulations of the responsible electrical utility company.



Typ 709062/ ...

Block diagram

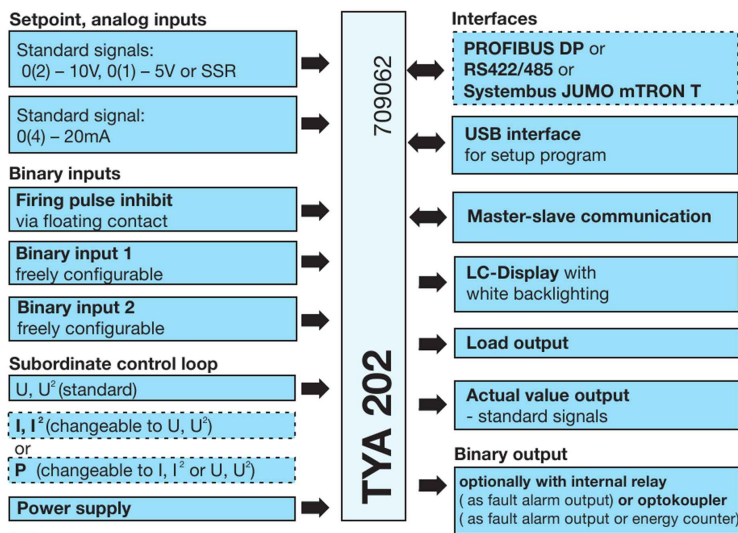

Approvals/approval marks (see "Technical data")



Special features

- LCD display with info line
- Simple configuration of the device via clear text display in the operator's language
- Setup program for configuration via USB interface
- Transmission of the setup data is also possible without voltage supply to the unit (supply via USB port)
- Close installation is possible
- Mains load optimization through dual energy management
- RS422/485 interface or
- PROFIBUS DP for connection to process control systems
- Systembus JUMO mTRON T or EtherCAT
- Softstart function with Burst-firing
- Burst-firing mode
- Resistance monitoring and limitation for MoSi₂ heating elements
- All versions in protection rating IP20
- Load monitoring for the detection of partial load failure or load short circuit "teach-in"
- Integrated diagnosis systems such as rotary-field detection
- Energy meter
- UL 508 Approval

Technical data

Voltage supply, load current

Code	Voltage supply for control electronics = max. load voltage	Fan specifications Type 709061/X-0X-250...
024	AC 24V -20%...+15%, 48 ...63 Hz	AC 24V/30VA
042	AC 42V -20%...+15%, 48 ...63 Hz	AC 24V/30VA
115	AC 115V -20%...+15%, 48 ...63 Hz	AC 115V/30VA
230	AC 230V -20%...+15%, 48 ...63 Hz	AC 230V/30VA
265	AC 265V -20%...+15%, 48 ...63 Hz	AC 230V/30VA
400	AC 400V -20%...+15%, 48 ...63 Hz	AC 230V/30VA
460	AC 460V -20%...+15%, 48 ...63 Hz	AC 230V/30VA
500	AC 500V -20%...+15%, 48 ...63 Hz	AC 230V/30VA
Load current $I_{L\ rms}$	AC 20, 32, 50, 100, 150, 200, 250A	
Load type	Resistive and resistive/inductive loads	
Control section power consumption	max. 40 VA	

Analog inputs

Control signal	0(4) ... 20mA	$R_i = 50\ \Omega$
	0(2) ... 10V	$R_i = 25\ k\Omega$
	0(1) ... 5V	$R_i = 25\ k\Omega$
Default set point value	Via standard signals (current, voltage) or interface	
	Base load:	Output as minimum control value
	Maximum control value:	Output as maximum control value
Example P control:		

Binary inputs

Binary input 1, 2	For connection to potential-free contact or optocoupler, voltage proof up to DC 12V
-------------------	---

Binary outputs, actual value output

Relay (changeover contact) without contact suppression	30000 switching actions at a contact rating of 3A/230V 50Hz (resistive load) B300 (UL 508)
Optocoupler output	$I_{Cmax} = 2\ mA$, $U_{CE0max} = 32\ V$
Actual value output	Switched off as standard. For standard signal, voltage: 0 ... 10V, 2 ... 10V, 0 ... 5V to 1 ... 5V For standard signal, current: 0 ... 20mA to 4 ... 20mA (burden max. 500 Ω) Depending on the device type, the output of various internal measuring values such as load current, load voltage or power is possible.

Thyristor firing request:	setpoint specification Current input (current proof up to 25mA)	setpoint specification Voltage input (voltage proof up to DC 32V)	setpoint specification Binary input1, 2 (voltage proof up to DC 32V)	via Interface
continuous	The power controller provides the power for the load continuously depending on the default setpoint value.	-	-	possible
logic (Solid State Relais SSR)	The power controller acts like a switch and provides the power by either switching ON or OFF. The switching level is always in the middle of the selected input range. At 4 to 20mA it is 12mA, at 0 to 10V it is 5V.	-	ON logic level „1“ = DC +2 to 32V OFF logic level „0“ = DC 0 to +0,8V	possible

General characteristic data

Circuit options	- Three-phase economy circuit in master/slave operation
Operating modes	- Burst-firing operation for resistive or transformer load with Softstart
Load types	All resistive loads through to inductive loads are permitted. For transformer loads the nominal induction of 1,2 Tesla must not be exceeded (for mains voltage peaks 1,45 T).
Special features	- Dual energy management - Burst-firing mode with softstart
Subordinate control loop	U ² control as standard Can be switched over to U, I, I ² , P control depending on device type
Electrical connection	For type 709062/X -0X-020... Control and load leads are connected via screw terminals. For type 709062/X -0X-032... Control leads are connected via screw terminals and load leads via cable lugs DIN 46235 and DIN46234 or tubular cable lugs.
Operating conditions	The controller is designed as a panel-mounting device according to: EN 50 178, pollution degree 2, overvoltage category Ü III
Electromagnetic compatibility	According to DIN 61326-1 Emitted interference: Class B Interference resistance: Industrial requirements
Protection rating	All device types IP20 according to EN 60 529
Protection rating	Protection rating I, with isolated control circuitry for connection to SELV circuits
Permissible ambient temperature range	0...40°C with forced air cooling (250A controller) 0 ... 45°C with natural air cooling (extended temperature range class 3K3 according to EN 60 721-3-3) At higher temperatures, operation with reduced type current is possible. (from 45°C with type current -2%/°C)
Permissible storage temperature range	-30 ... +70 °C (1K5 according to EN 60 721-3-1)
Site altitude	≤ 2000m above sea level
Cooling	- Natural convection up to a load current of 200A - For a load current of 250A, forced convection with built-in ventilator - At site altitudes over 1000 m, the current carrying capacity of the power controller decreases
Environmental performance	Rel. humidity ≤ 85 % annual average, no condensation 3K3 according to EN 60 721
Installation position	Vertical
Test voltage	According to EN 50178
Creepage distances	8 mm between supply current circuit and SELV circuits for type 709062/X -0X-020... 12.7 mm between supply current circuit and SELV circuits from type 709062/X -0X-032... SELV = Separate Extra Low Voltage (safe low voltage)
Case	Plastic, flammability class UL94 V0, color: Cobalt blue RAL 5013
Power dissipation	The power dissipation can be calculated using the following empirical formula: $P_v = 2 \times (20W + 1.3V \times I_{Load} A)$
Maximum temperature of the cooling body	110°C
A/D converter resolution	12 Bit



Type (Load current)	20A	32A	50A	100A	150A	200A	250A
Weight	approx. 2.2 kg	approx. 4.2 kg	approx. 5.4 kg	approx. 7.6 kg	approx. 17 kg	approx. 19 kg	approx. 20.4 kg

Approvals/approval marks

Approval mark	Testing agency	Certificates / certification numbers	Inspection basis	Valid for
	Underwriters Laboratories	E223137	UL 508 (Category NRNT), pollution degree 2 C22.2 NO. 14-10 Industrial Control Equipment (Category NRNT7)	709062/X-XX-020-... Load current 20 A
			UL 508 (Category NRNT) C22.2 NO. 14-10 Industrial Control Equipment (Category NRNT7)	709062/X-XX-032... 709062/X-XX-050... 709062/X-XX-100... 709062/X-XX-150... 709062/X-XX-200... 709062/X-XX-250... Load current 32...250 A

Display and measuring accuracy

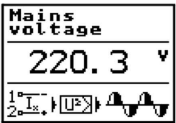
All specifications refer to the controller nominal data.

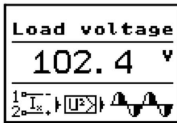
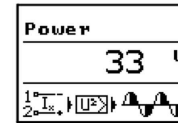
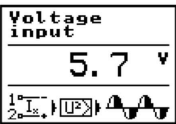
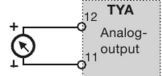
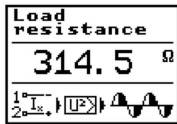
Supply voltage: ± 2,5% 	Load current: ± 1% 	Load voltage: ± 1% 	Power: ± 2% 	
Analog input Voltage/current: ± 1% 	Analog output Voltage/current: ± 1% 	Load resistance: ± 2% (for resistive load) 		

Permissible load current depending on the ambient temperature and site altitude

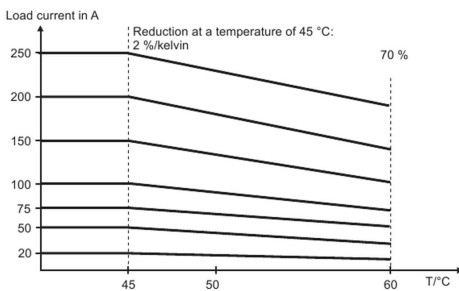

Note:

At a device temperature of 105°C, the load current is reduced for each degree of temperature increase.

The power controller current is switched off completely at a device temperature of >115°C.

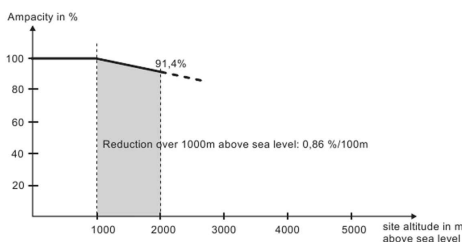

Note:

The altitude is ≤ 2000m above sea level.

In the case of air cooling, it must be noted that the effectiveness of the cooling is reduced the higher up the device is installed. As a result, the current carrying capacity of the Thyristor power controller decreases with such a cooler as the site altitude increases as shown in the image.

Electrical isolation

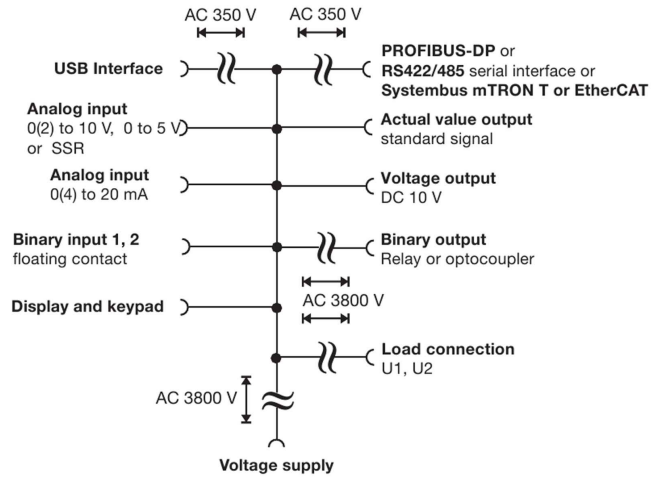

Display, operation and connection elements

Legend	Remark	Fig.
1	LED Power (green) is lit when the voltage supply is connected	
2	LCD display with white background lighting (96 x 64 pixels). (no LCD display on Slave device) The info line at the bottom of the display indicates current settings and error messages.	
3	The LED Fuse (red) is lit when the semi-conductor fuse is blown	
4	LED K1 (yellow) fault signal output	
5	Keys: Increase value / parameter up Decrease value / parameter down Abort / one level back Programming / one level lower (no Keys on Slave device)	
6	USB setup interface Konfiguration data is set on the left device and will be transmitted automatically via 1:1 Patch cable to the right device.	
7	Release clip for removing the plastic case (push to the right)	

Dimensions

Type 709062/X-0X-20A-XXX-XXX-XX-25X

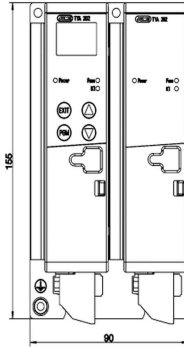
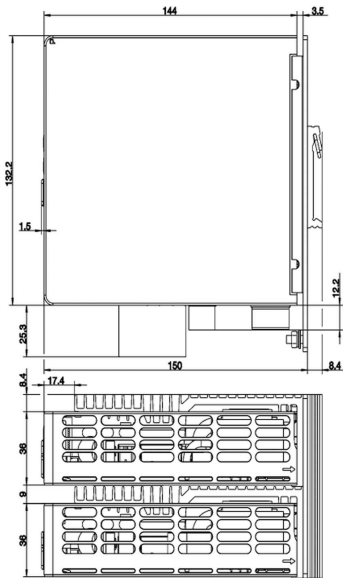

Type 709062/X-0X-032-XXX-XXX-XX-25X

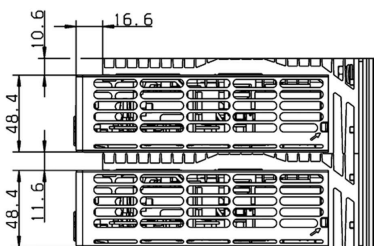
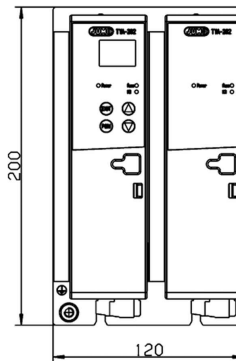
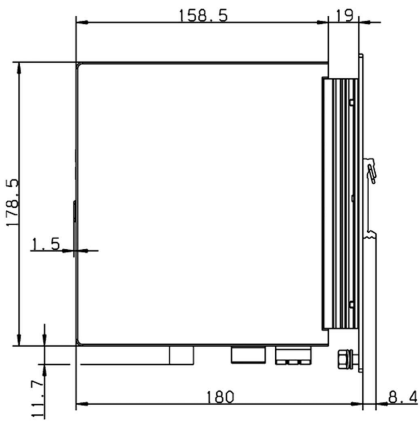

Type 709062/X-0X-050-XXX-XXX-XX-25X

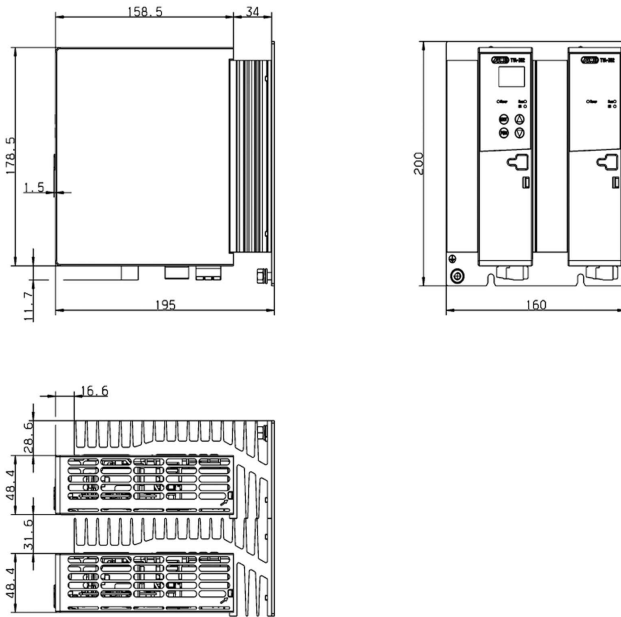

Type 709062/X-0X-100-XXX-XXX-XX-25X

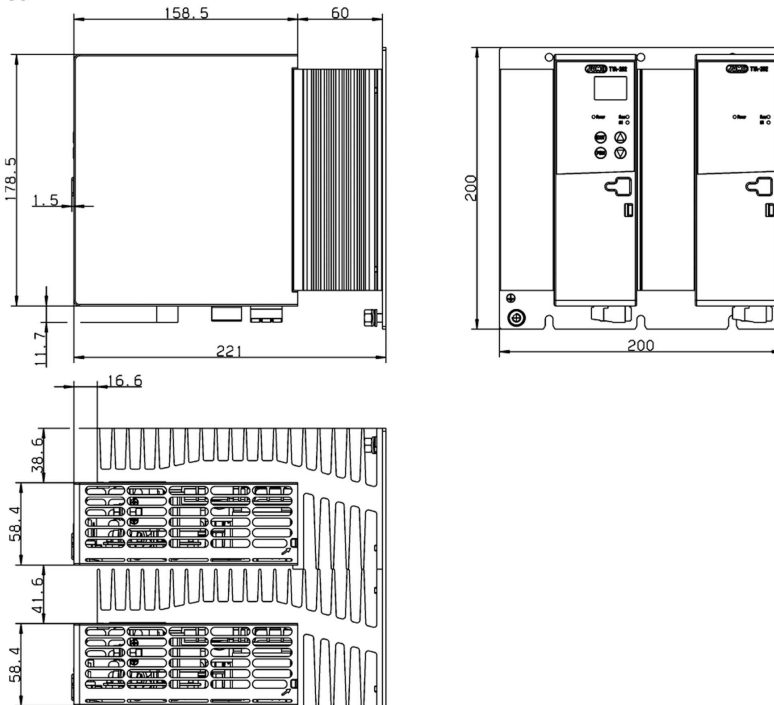

Type 709062/X-0X-150-XXX-XXX-XX-25X
 Type 709062/X-0X-200-XXX-XXX-XX-25X,

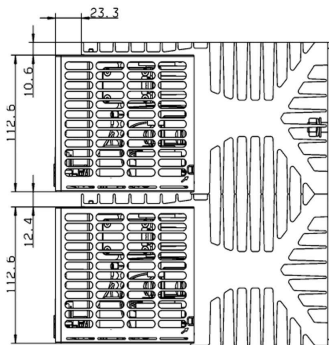
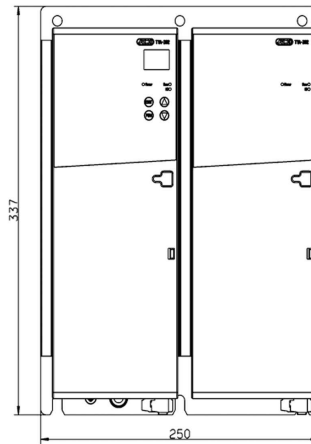
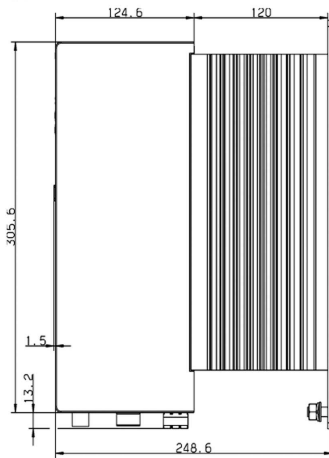

Clearances (all types)

- Allow a clearance of 10 cm from the floor.
- Allow a clearance of 15 cm from the ceiling.
- When fitted next to each other, no spacing between the devices is required.

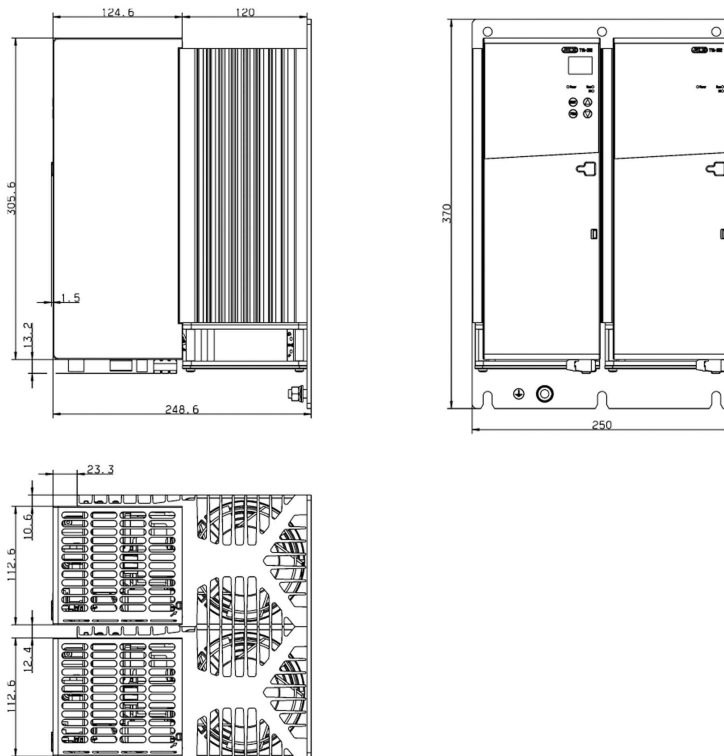
Type 709062/X-0X-250-XXX-XXX-XX-25X

Maximum tightening torques for screw connections

Terminals	Version	Tightening torque
For all types X2_1 numbers 1...6, X2_2 numbers 7...12 and modbus RS422/485 (Terminals 16, 17, 18, 19)	Plug-in screw terminals (slotted screws)	0.25 Nm
X3 numbers 13, 14, 15	Plug-in screw terminals (slotted screws)	0.5 Nm
Type 709062/X-0X-020... Clamping block U1, U2, N/L2, V, L1 Ground terminal PE:	Plug-in screw terminals (recessed head screws) M4 headless setscrew with nut	0.6 Nm 3 Nm
Type 709062/X-0X-032 and type 709062/X-0X-050... U1, U2: Clamping block N/L2, V, L1 Ground terminal PE:	M6 recessed head screws Plug-in screw terminals (slotted screws) M6 headless setscrew with nut	5 Nm 0.5 Nm 5 Nm
Type 709062/X-0X-100... U1, U2: Clamping block N/L2, V, L1 Ground terminal PE:	M6 hexagon screw, width across flats 10 mm Plug-in screw terminals (slotted screws) M6 headless setscrew with nut	5 Nm 0.5 Nm 5 Nm
Type 709062/X-0X-150..., 709062/X-0X-200 and Type 709062/X-0X-250... U1, U2: Clamping block N/L2, V, L1 Ground terminal PE:	M8 hexagon screw, width across flats 13 mm Plug-in screw terminals (slotted screws) M8 headless setscrew with nut	12 Nm 0.5 Nm 12 Nm
Typ 709061/X-0X-250... X14 numbers 20, 21	Plug-in screw terminals (slotted screws)	0,5 Nm

Connection diagram

The connection diagram contained in the data sheet provides a first information about the connection possibilities. Only use the installation instructions or the operating manual for the electrical connection. The knowledge and the correct technical execution of the safety information/instructions contained in these documents are prerequisite for installation, electrical connection and commissioning/start-up as well as for safety during operation.

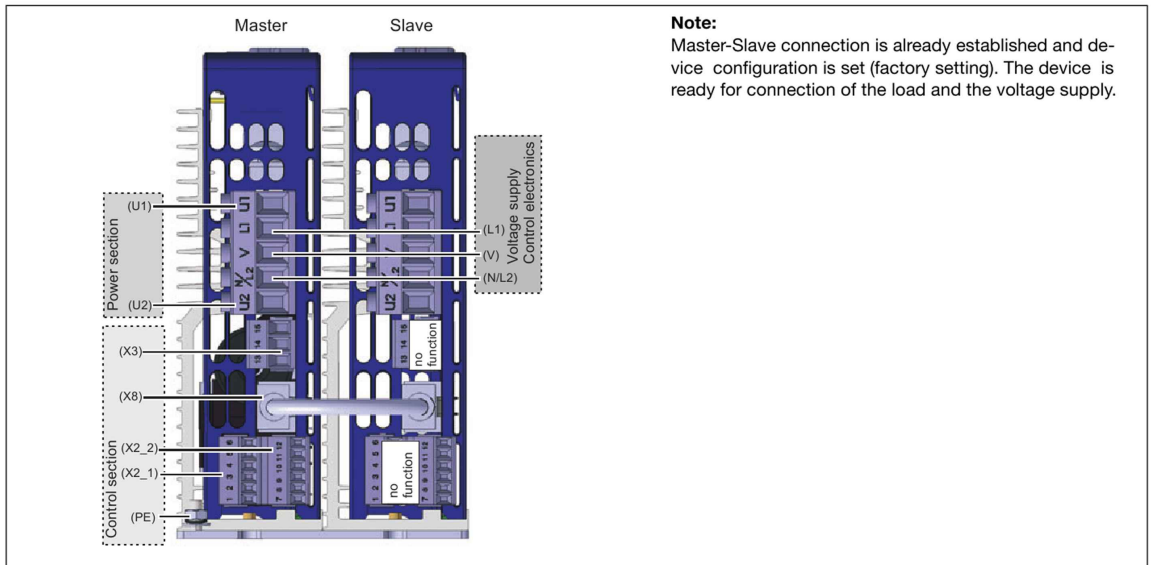
Typ 709062/X-0X-20-XXX-XXX-XX-25X



Note:
Master-Slave connection is already established and device configuration is set (factory setting). The device is ready for connection of the load and the voltage supply.

Power section		
Connection for	Screw terminals, control section/power section	Detail
Voltage supply for control electronics (corresponds to maximum load voltage of ordered device type)	L1 N/L2 V	
Load connection	U1 U2	
Protection conductor	PE	
Fan X14	20, 21 (only for load current of 250 A)	

Control section

Connection for	Screw terminal X2_1	Detail
Setpoint specification for current input	1 2	
Setpoint specification for voltage input (surge proof up to max. DC 32 V)	3 (GND) 4	
Output DC 10 V fixed voltage	5	
Ground potential	6 (GND)	external Setpoint specification with potentiometer

Connection for	Screw terminal X2_2	Detail
Firing pulse inhibit ON logical "1" = DC 2 to 32 V OFF logical "0" = DC 0 to 0.8 V	8	
Digital input1 ON logical "1" = DC 2 to 32 V OFF logical "0" = DC 0 to 0.8 V	9	
Digital input2 ON logical "1" = DC 2 to 32 V OFF logical "0" = DC 0 to 0.8 V	10	
GND Analog output for various internal controller variables	7, 11 12	Ground potential

Master-slave connection

Connection for	RJ 45 socket X8
Master-Slave-operation	The 1:1 Patch cable (included in the scope of delivery) has to be connected for correct operation.

Fault signal output

Connection for	Screw terminal X3	Detail
Relay or optocoupler is on Slave2 at load current of 20 A and on Master at 32...250 A	13 N/O contact or collector 14 N/C contact 15 pole or emitter	

Interfaces (Option)

Modbus connection	RS422	RS485	JUMO mTRON T system bus	Connection	PROFIBUS-DP
	TxD (-) TxD (+) RxD (-) RxD (+)	RxD/TxD B(-) RxD/TxD A(+) - -		1 TX+ Transmission data+ 2 TX- Transmission data - 3 RX+ Received data + 6 RX Received data -	SUB-D socket 9-pin (on the front)
Pluggable screw terminals on the underside of the housing					
The shield of the Modbus cables must be routed on ground potential (PE)	(RS422/485 Modbus)		2 RJ-45 sockets (on the front)		3 A(+) 8 B(-) 6 VCC 5 GND Shielding

Typ 709062/X-0X-032-XXX-XXX-XX-25X

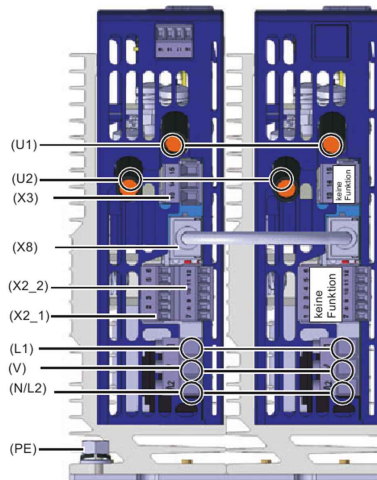

Typ 709062/X-0X-050-XXX-XXX-XX-25X

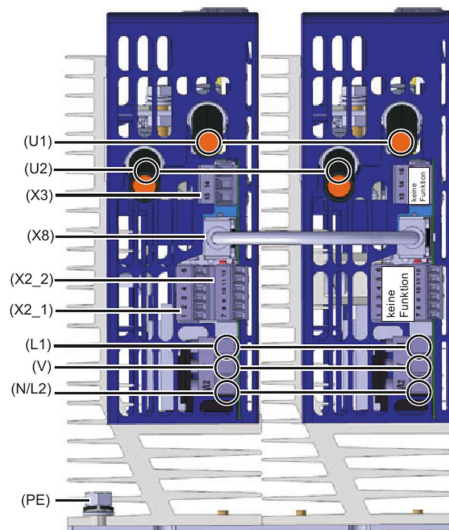

Typ 709062/X-0X-100-XXX-XXX-XX-25X

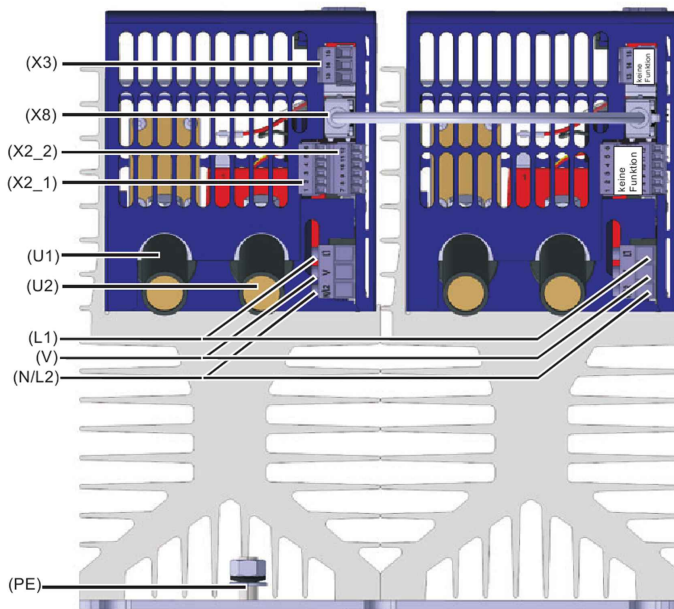

Typ 709062/X-0X-150-XXX-XXX-XX-25X,

Typ 709062/X-0X-200-XXX-XXX-XX-25X

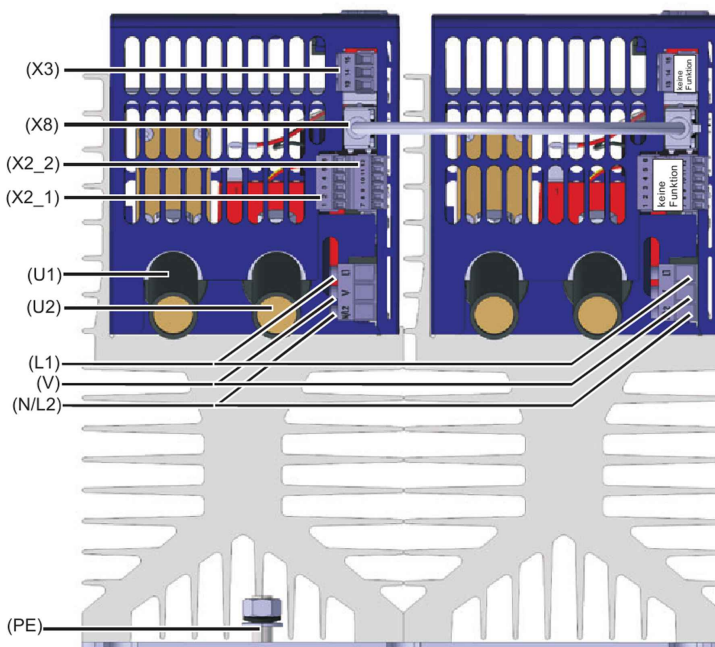

Typ 709062/X-0X-250-XXX-XXX-XX-25X

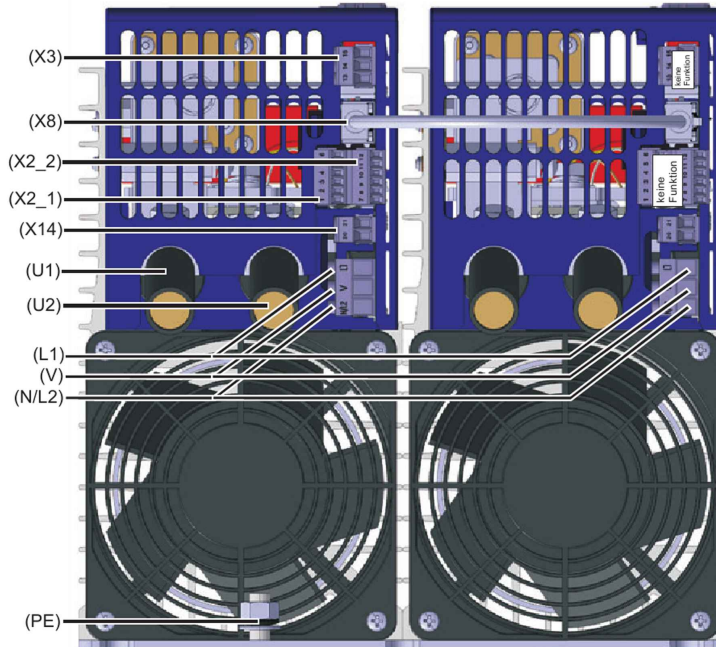

Example:

Voltage supply of the fan in case of type 709062/X-0X-250-XXX-400-XX-25X

Depending on the load voltage, the fan terminal X14 must be supplied with the voltage specified below.

The lead protection must be between 2 A and a maximum of 5 A.

The fan is temperature-controlled, switches on automatically when the device temperature reaches 85 °C, and remains in operation until the device temperature falls below 70 °C.

Load voltage on the power controller	Tolerances	Fan specifications
Load voltage AC 24V	-20 to +15 %, 48 to 63 Hz	AC24V / 30VA
Load voltage AC 42V		
Load voltage AC115V	-15 to +10 %, 48 to 63 Hz	AC 115V / 30VA
Load voltage AC230V		AC 230V / 30VA
Load voltage AC265V		
Load voltage AC400V		
Load voltage AC460V		
Load voltage AC500V		

Wiring

Three-phase economy circuit Master-Slave for resistive loads in star-, delta connection or transformer loads (resistive-inductive)

Attention:

- Make sure that the rotating electrical field is right-handed!
- Only possible in burst firing mode

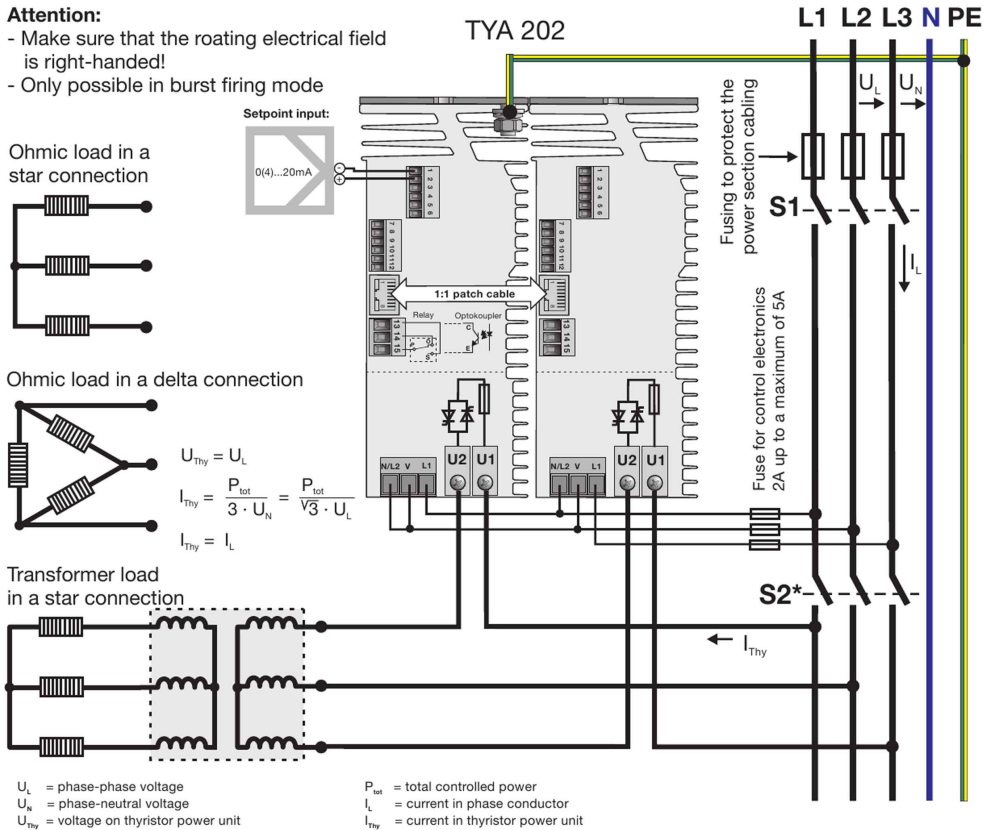

* see switch on sequence if bus-systems are used

Observe the general switch-on sequence

The **S2** switch is not required if no bus system is used. The control section and power section are switched on simultaneously via switch **S1**. This is particularly important for the operation of transformer loads and resistance loads with a high temperature coefficient ($TC \gg 1$). This makes sure the necessary load start functions (soft start, current limiting, etc.) are activated accordingly. Under no circumstances should the voltage supply for the control electronics be switched on before the load voltage!

Switch-on sequence when using bus systems

When using a bus system, the control section and power section are switched on simultaneously via **S1** and **S2**. If a bus system is supplied directly from the TYA's control section, the **TYA's control section must remain connected to the mains voltage at all times** (e.g. **S1** permanently connected). **S2** is used to activate the load. In the event of transformer loads or loads with a large temperature coefficient ($TC \gg 1$), the controller output must be blocked using the inhibit function prior to opening **S2**. After closing **S2**, the controller output must be reactivated via the inhibit function.

Note:

In the case of power controllers with a load current of 250 A, the fan terminal X14 must also be supplied with the specified voltage! See "Example: Voltage supply of the fan in case of type 709062/X-0X-250-XXX-400-XX-25X" see page 14.

Order details

(1) Basic type

709062	TYA 202 Thyristor Power Controller in a three-phase economy circuit
--------	---

(2) Version

8	Standard with factory settings
9	Customer-specific programming according to specifications

(3) National language of display texts

01	German (set at factory)
02	English
03	French

(4) Load current

020	AC 20 A
032	AC 32 A
050	AC 50 A
100	AC 100 A
150	AC 150 A
200	AC 200 A
250	AC 250 A

(5) Subordinate control loop

100	U, U²
010	I, I² (can be set to U, U ²)
001	P (can be set to I, I ² or U, U ²)

(6) Load voltage^a

024	AC 24 V	-20 to +15 %, 48 to 63 Hz
042	AC 42 V	-20 to +15 %, 48 to 63 Hz
115	AC 115 V	-20 to +15 %, 48 to 63 Hz
230	AC 230 V	-20 to +15 %, 48 to 63 Hz
265	AC 265 V	-20 to +15 %, 48 to 63 Hz
400	AC 400 V	-20 to +15 %, 48 to 63 Hz
460	AC 460 V	-20 to +15 %, 48 to 63 Hz
500	AC 500 V	-20 to +15 %, 48 to 63 Hz

(7) Interface

00	None
54	RS485/422
64	PROFIBUS-DP
84	Systembus JUMO mTRON T or EtherCAT

(8) Extra codes

252	Relay (changeover contact) 3 A
257	Optocoupler ^b

(1) (2) (3) (4) (5) (6) (7) (8)
 [] / [] - [] - [] - [] - [] - [] / [] Order code
 709062 / 8 - 01 - 100 - 100 - 400 - 00 / 252 Order example

a Load Voltage = voltage supply for control electronics

b Enables energy meter

Important **Subordinate control loop U, U²** code 100: voltage control

information: **Subordinate control loop I²**, code 010: enables voltage control, current control, partial load failure detection, dual energy management, current limiting and energy meter

Subordinate control loop P, code 001: enables voltage control, current control, power control, partial load failure detection, dual energy management, current limiting, r-control and and energy meter

Note fan voltage at 250 A load current!

Scope of delivery

1 Operating Manual
1 Thyristor power controller in the version ordered
1:1 Patch cable

Accessories

Part	Part no.
Setup program 70.9061 (TYA 201) and 70.9062 (TYA 202)	00544869
USB cable A-plug B-plug 3m	00506252
Mounting kit for DIN rail installation:	
Installation kit for mounting rail 20A TYA 202	00555172
Installation kit for mounting rail 32A TYA 202	00555527
Installation kit for mounting rail 50A TYA 202	00600097

General accessories

Part	Load current $I_{nom.} = I_N$	Part no.
Super fast semi-conductor fuse 40A-AC690V	$I_N = 20A$	00513108
Super fast semi-conductor fuse 80A-AC690V	$I_N = 32A$	00068011
Super fast semi-conductor fuse 80A -AC690V	$I_N = 50A$	00068011
Super fast semi-conductor fuse 160A-AC690V	$I_N = 100A$	00081801
Super fast semi-conductor fuse 350A -AC690V	$I_N = 150A$	00083318
Super fast semi-conductor fuse 550A-AC690V	$I_N = 200A$	00083318
Super fast semi-conductor fuse 550A -AC690V	$I_N = 250A$	00083318