

Innovative Service Around the Globe **YAGEO**

# DATA SHEET

## WIREWOUND RESISTORS

General Purpose

KNP Series

$\pm 1\%$ ,  $\pm 2\%$ ,  $\pm 5\%$

1/4W to 7W

RoHS compliant & Halogen Free



Product specification – November 10, 2023 V.3



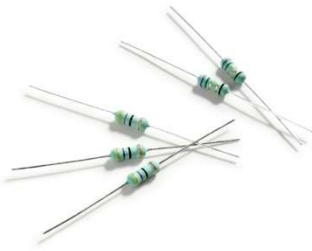

**APPLICATIONS**

- Power applications
- Home appliance
- Industry

**FEATURES**

- Higher power rating
- Wide resistance range
- High stable performance and high reliability
- Flameproof coating equivalent to UL-94V-0
- RoHS compliant & halogen-free

**ORDERING INFORMATION**

Part number of the wirewound resistor is identified by the series, power rating, tolerance, packing, temperature coefficient, forming and resistance value and suffix.

**PART NUMBER**

<b>KNP</b> (1)	<b>2WS</b> (2)	<b>J</b> (3)	<b>T</b> (4)	<b>-</b> (5)	<b>73-</b> (6)	<b>30R</b> (7)	<b>NO</b> (8)
-------------------	-------------------	-----------------	-----------------	-----------------	-------------------	-------------------	------------------

**(1) SERIES**

KNP Series

**(2) POWER RATING**

-25 = 1/4W	200 = 2W	500 = 5W
50S = 1/2W	3WS = 3W	600 = 6W
-50 = 1/2W	3SS = 3W	700 = 7W
1WS = 1W	300 = 3W	7WS = 7W
100 = 1W	400 = 4W	
2WS = 2W	5WS = 5W	

**(3) TOLERANCE**

F = ±1%	G = ±2%	J = ±5%
---------	---------	---------

**(4) PACKAGING**

T = Box Pack	R = Reel Pack	B = Bulk
--------------	---------------	----------

**(5) TEMPERATURE COEFFICIENT OF RESISTANCE**

- = Based on spec.

**(6) FORMING**

52- = 52.4mm	FK = FK Type
73- = 73mm	FFK = F-form Kink
91- = 91mm	FKK = FKK Type
M = M-Type Forming	FT = FT Type Forming
MB = M-form W/flat	PN = PANAsert
F = F Type	AV = AVIsert

**(7) RESISTANCE VALUE**

E24 & E96 Series  
 Example:  
 0R1= 0.1Ω, 100R= 100Ω, 1K = 1,000Ω

**(8) SUFFIX**

Optional code. required only when resistor is with pulse/surge specification.  
 Example: NO, CM, CN, CU, CY, FB, FC, NS, NM, CR, NL, NJ etc.  
 Null = Standard Type.

**DIMENSIONS**

Unit: mm

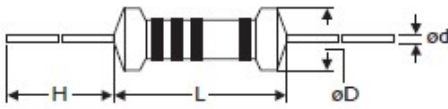

Normal	Miniature	L	ψD	H	ψd
KNP-25	KNP50S	6.3 ± 0.5	2.5 ± 0.3	28 ± 2.0	0.55 ± 0.05
KNP-50	KNP1WS	9.0 ± 0.5	3.5 ± 0.3	26 ± 2.0	0.55 ± 0.05
KNP100	KNP2WS	11.5 ± 1.0	4.6 ± 0.5	35 ± 2.0	0.8 ± 0.05
	KNP3SS	11.5 ± 1.0	4.6 ± 0.5	35 ± 2.0	0.8 ± 0.05
KNP200	KNP3WS	15.5 ± 1.0	5.2 ± 0.5	33 ± 2.0	0.8 ± 0.05
KNP300	KNP5WS	17.5 ± 1.0	6.2 ± 0.5	32 ± 2.0	0.8 ± 0.05
KNP400		17.5 ± 1.0	6.2 ± 0.5	32 ± 2.0	0.8 ± 0.05
KNP500	KNP7WS	24.5 ± 1.0	8.2 ± 0.5	38 ± 2.0	0.8 ± 0.05
KNP600		24.5 ± 1.0	8.2 ± 0.5	38 ± 2.0	0.8 ± 0.05
KNP700	-	24.5 ± 1.0	8.2 ± 0.5	38 ± 2.0	0.8 ± 0.05

**DERATING CURVE**

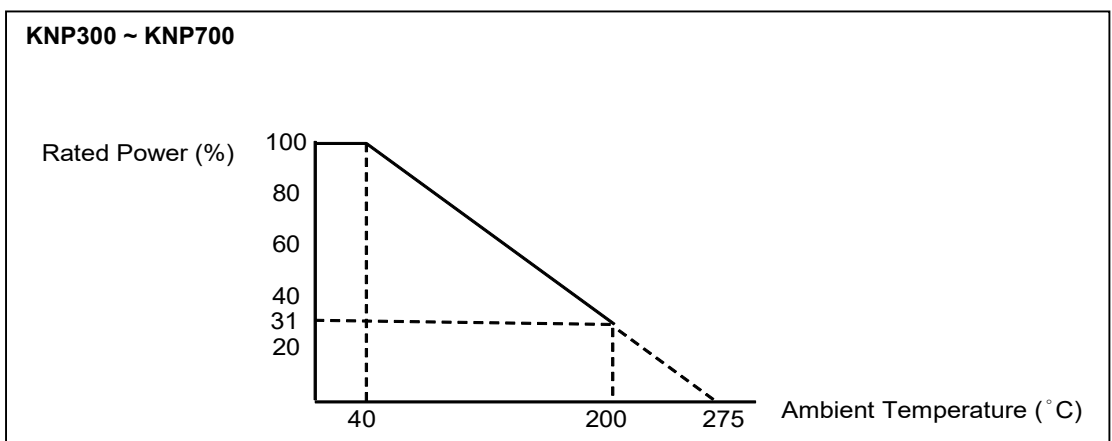
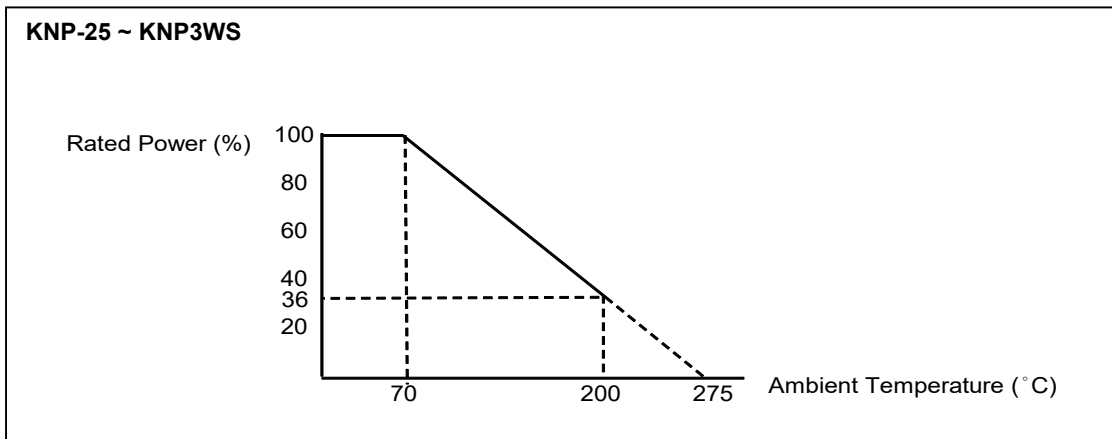

**ELECTRICAL CHARACTERISTICS**

CHARACTERISTICS	KNP-25	KNP-50	KNP100	KNP200	KNP300	KNP400	KNP500	KNP600	KNP700
Power Rating at 40 °C					3W	4W	5W	6W	7W
Power Rating at 70 °C	1/4W	1/2W	1W	2W					
Resistance Range (±1%)	0.1Ω - 150Ω	0.1Ω - 750Ω	0.1Ω - 1.5KΩ	0.1Ω - 2.4KΩ	0.1Ω - 3.3KΩ	0.1Ω - 3.3KΩ	0.1Ω - 6.2KΩ	0.1Ω - 6.2KΩ	0.1Ω - 6.2KΩ
Resistance Range (±2% & ±5%)	0.1Ω - 200Ω	0.1Ω - 800Ω	0.1Ω - 2.2KΩ	0.1Ω - 2.7KΩ	0.1Ω - 3.9KΩ	0.1Ω - 3.9KΩ	0.1Ω - 6.8KΩ	0.1Ω - 6.8KΩ	0.1Ω - 6.8KΩ
Voltage Proof on Insulation	250V	300V	400V	400V	400V	400V	400V	400V	400V
Maximum working voltage	$\sqrt{(P \times R)}$								
Operating Temp. Range	- 40°C to +200°C								
Temperature Coefficient	±300ppm/°C								

Note: For resistance value out of above range is by request.

CHARACTERISTICS	KNP50S	KNP1WS	KNP2WS	KNP3SS	KNP3WS	KNP5WS	KNP7WS
Power Rating at 40 °C						5W	7W
Power Rating at 70 °C	1/2W	1W	2W	3W	3W		
Resistance Range (±1%)	0.1Ω - 150Ω	0.1Ω - 750Ω	0.1Ω - 1.5KΩ	0.1Ω - 1.5KΩ	0.1Ω - 2.4KΩ	0.1Ω - 3.3KΩ	0.1Ω - 3.3KΩ
Resistance Range (±2% & ±5%)	0.1Ω - 200Ω	0.1Ω - 800Ω	0.1Ω - 2.2KΩ	0.1Ω - 2.2KΩ	0.1Ω - 2.7KΩ	0.1Ω - 3.9KΩ	0.1Ω - 3.9KΩ
Voltage Proof on Insulation	200V	300V	400V	400V	400V	400V	400V
Maximum working voltage	$\sqrt{(P \times R)}$						
Operating Temp. Range	- 40°C to +200°C						
Temperature Coefficient	±300ppm/°C						

Note: For resistance value out of above range is by request.

**TEST AND REQUIREMENTS**

TEST	TEST METHOD	PROCEDURE	APPRAISE
Short Time Overload	IEC 60115-1 4.13	10 times rated power for 5 sec.	±2%+0.05Ω
Voltage Proof on Insulation	IEC 60115-1 4.7	In V-Block for 60 sec. test voltage as above table	No Breakdown
Temperature Coefficient	IEC 60115-1 4.8	Between -40°C to +155°C	By Type
Insulation Resistance	IEC 60115-1 4.6	In V-Block for 60 sec.	>100MΩ
Solderability	IEC 60115-1 4.17	245±5°C for 3±0.5 Sec.	95% Min. coverage
Solvent Resistance of Marking	IEC 60115-1 4.30	IPA for 5±0.5 Min. with ultrasonic	No deterioration of coatings and markings
Robustness of Terminations	IEC 60115-1 4.16	Direct load for 10 Sec. in the direction of the terminal leads	≥2.5Kg(24.5N)
Damp Heat Steady State	IEC 60115-1 4.24	40±2°C,90-95% RH for 56 days, loaded with 0.1 times RCWV	±5.0%+0.05Ω
Endurance at 70°C	IEC 60115-1 4.25	70±2°C at RCWV (or Umax., whichever less) for 1,000 Hr.(1.5 Hr.on,0.5 Hr. off)	±5.0%+0.05Ω
Temperature Cycling	IEC 60115-1 4.19	→ -55°C → Room Temp. → +155°C Room Temp. (5 cycles)	±1.0%+0.05Ω
Resistance to Soldering Heat	IEC 60115-1 4.18	260±3°C for 10±1 Sec., immersed to a point 3±0.5mm from the body	±1.0 %+0.05Ω
Accidental Overload Test	IEC 60115-1 4.26	4 times RCWV for 1 Min.	No evidence of flaming or arcing

Note:

**RCWV (Rated Continuous Working Voltage):**

The DC or AC (rms) continuous working voltage corresponding to the rated power is determined by the following formula:

$$V=\sqrt{P \times R}$$

or max. working voltage whichever is less

Where

V=Continuous rated DC or  
AC (rms) working voltage (V)

P=Rated power (W)

R=Resistance value (Ω)

**PULSE DIAGRAMS**

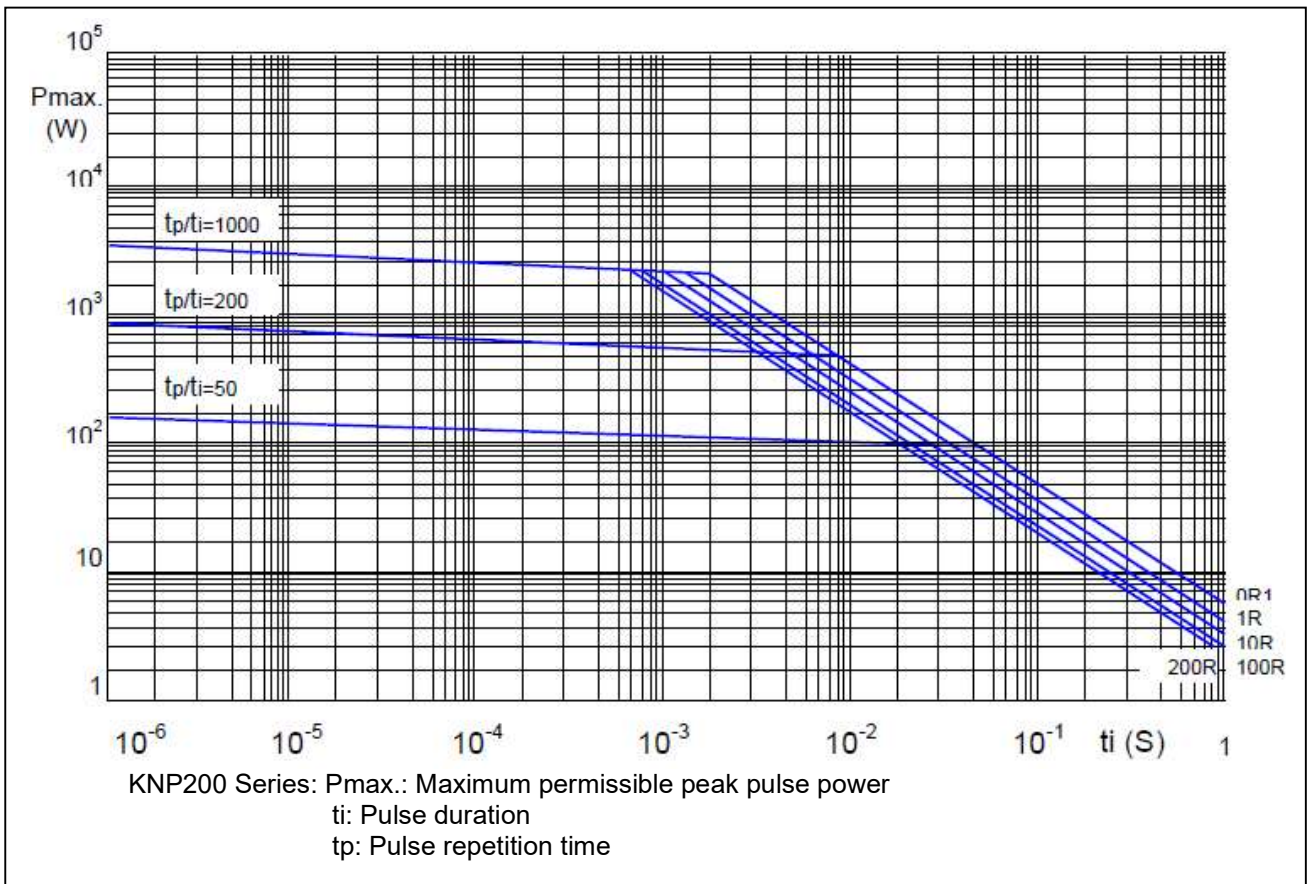
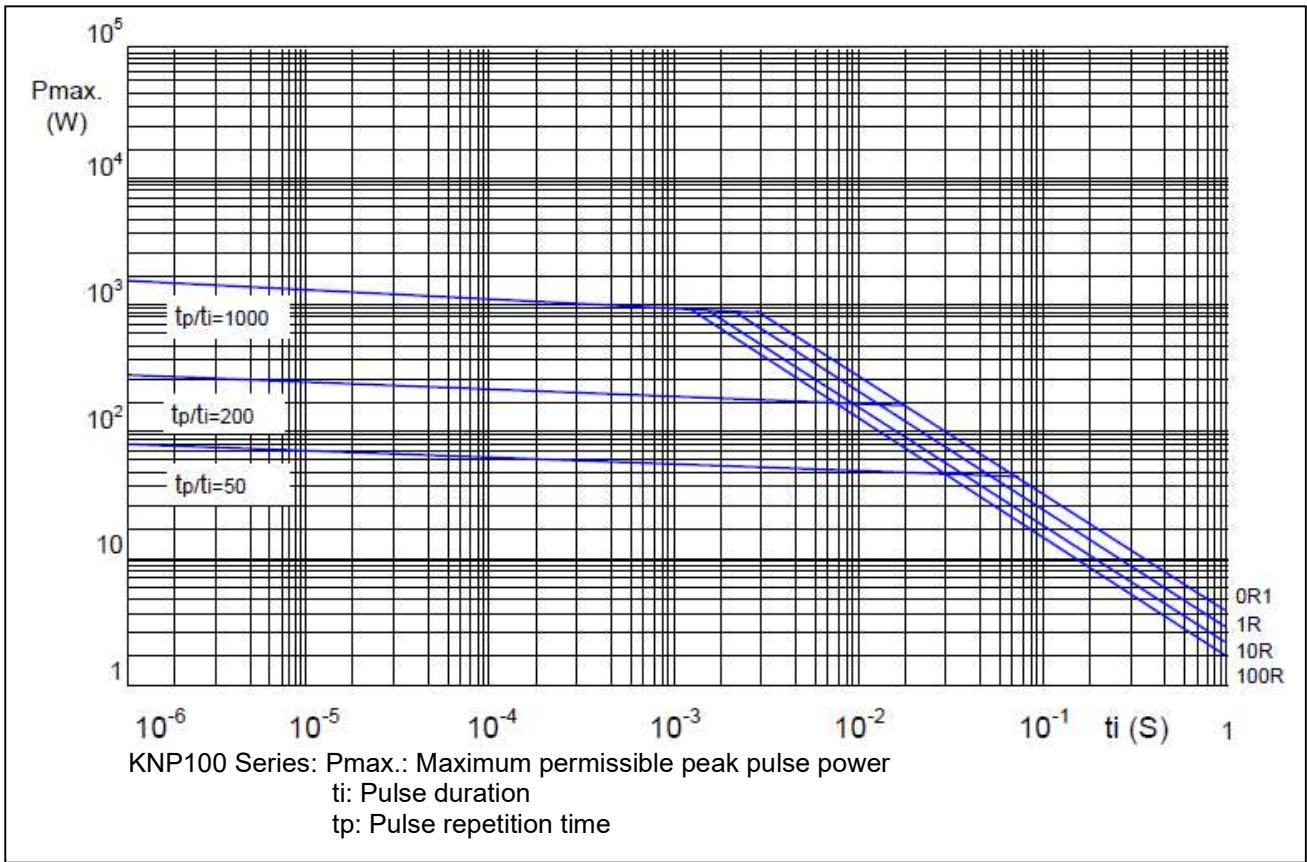

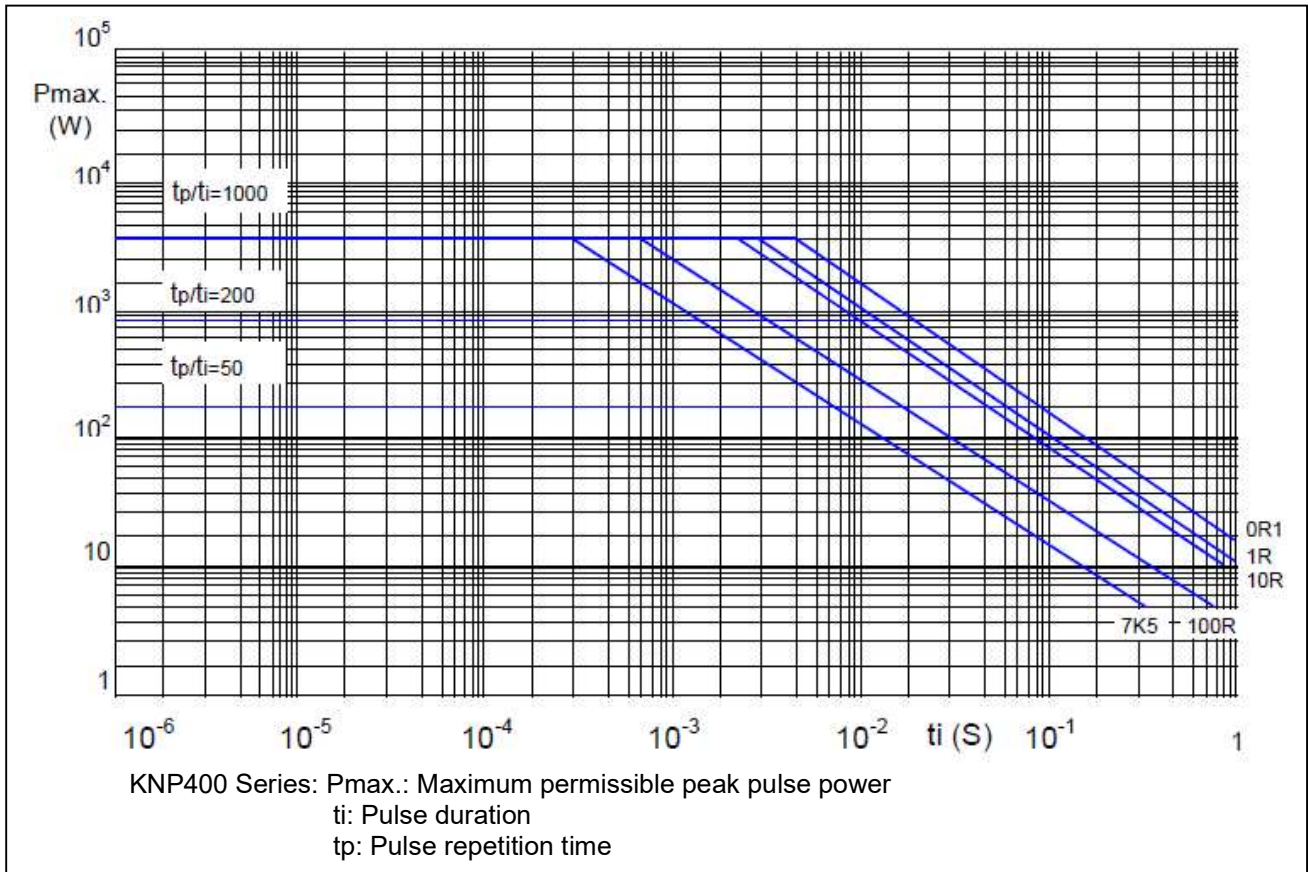
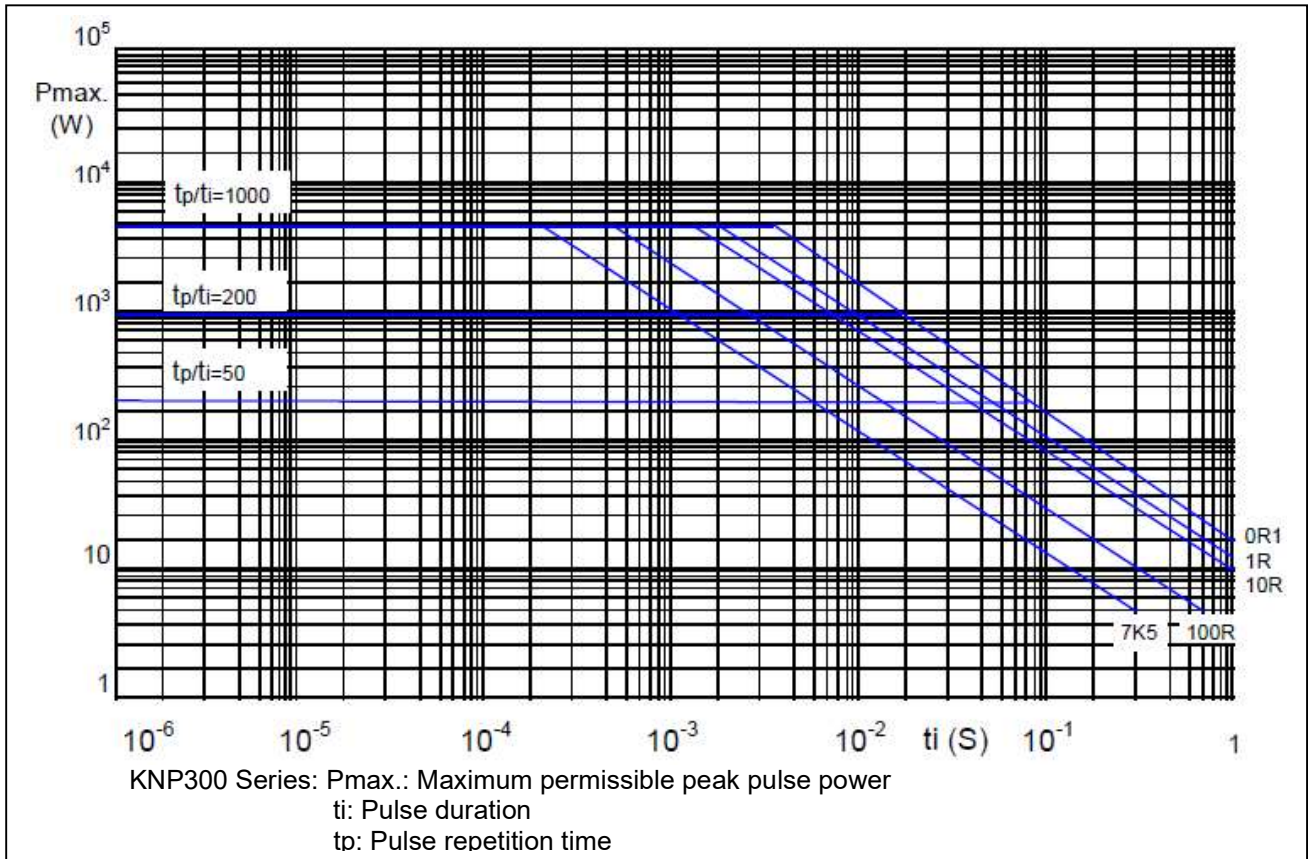

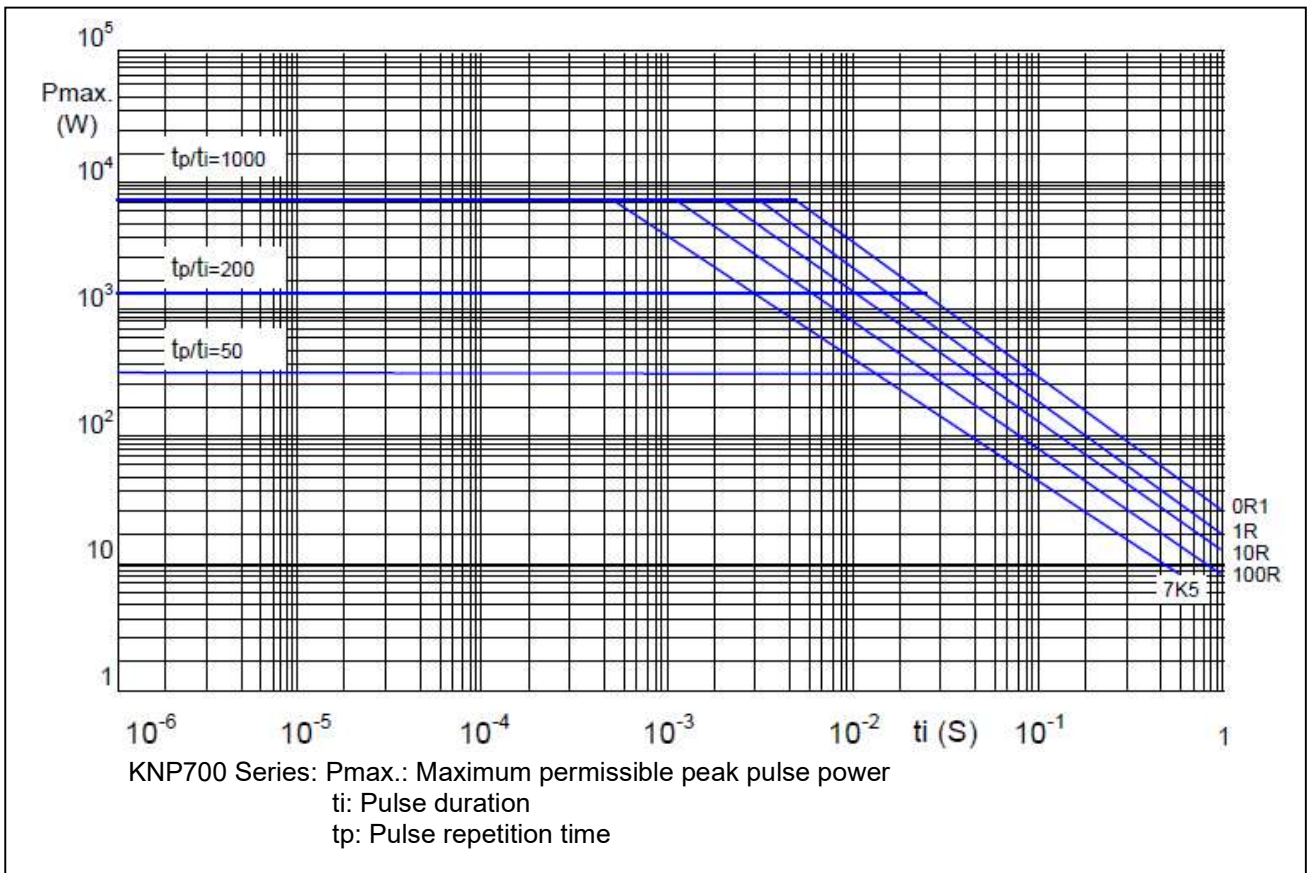
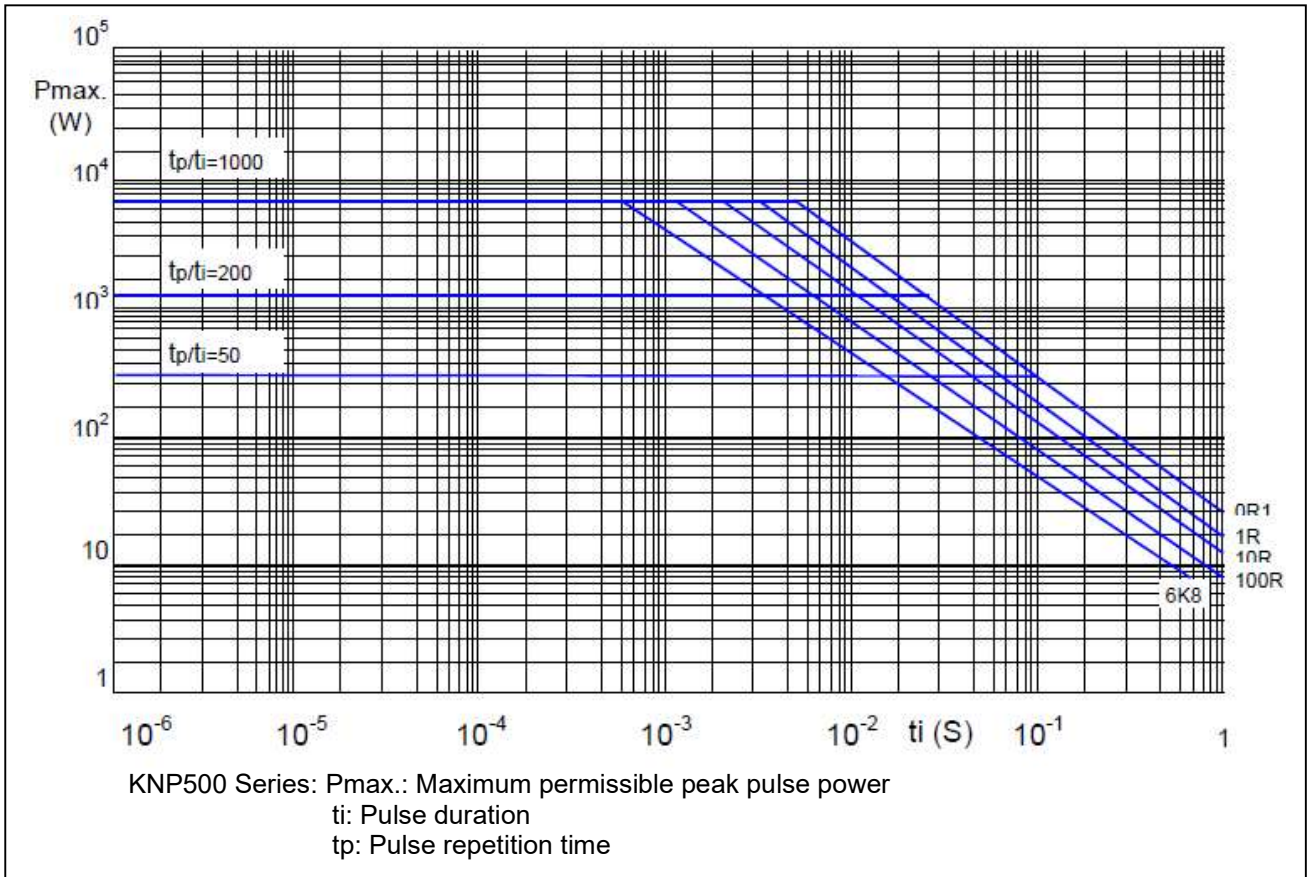

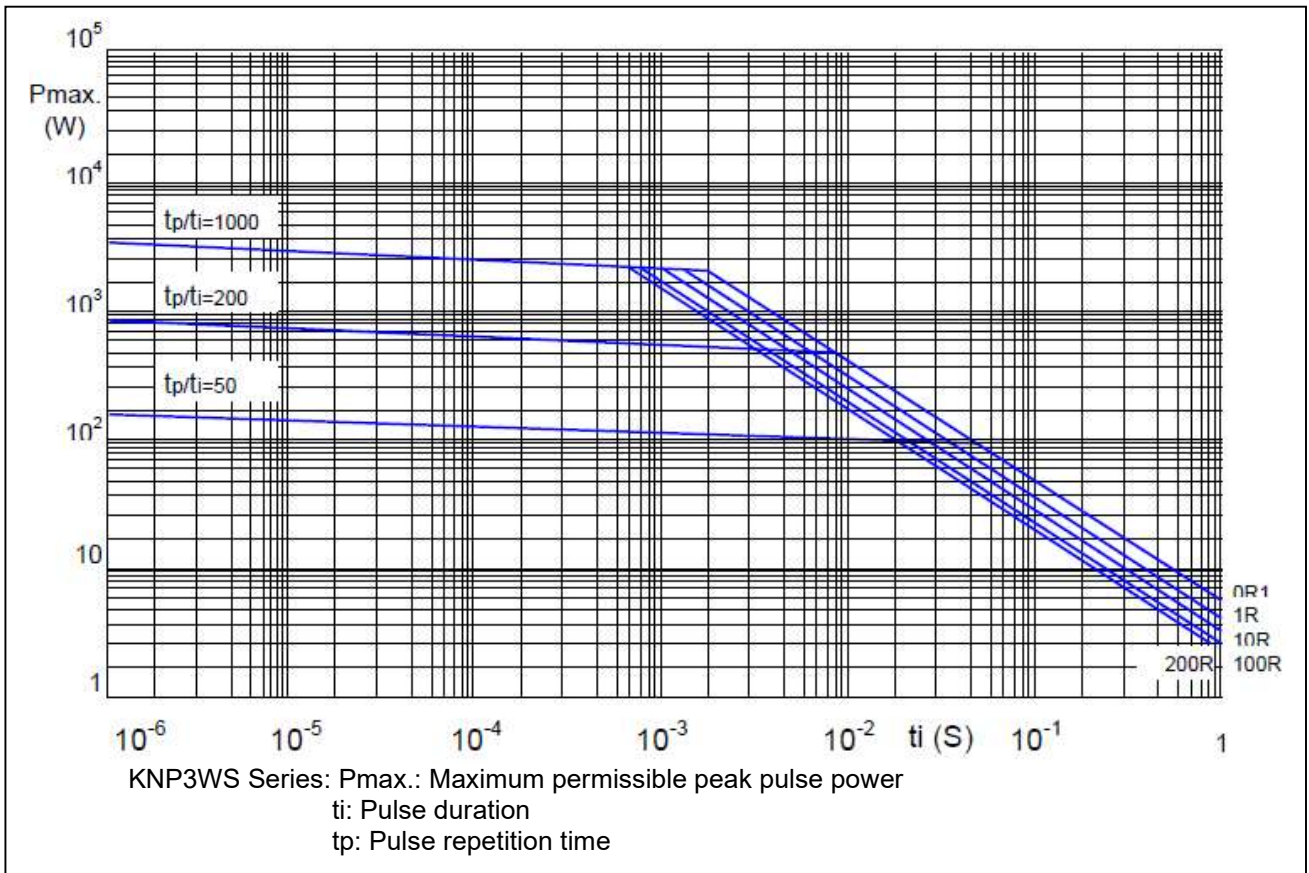
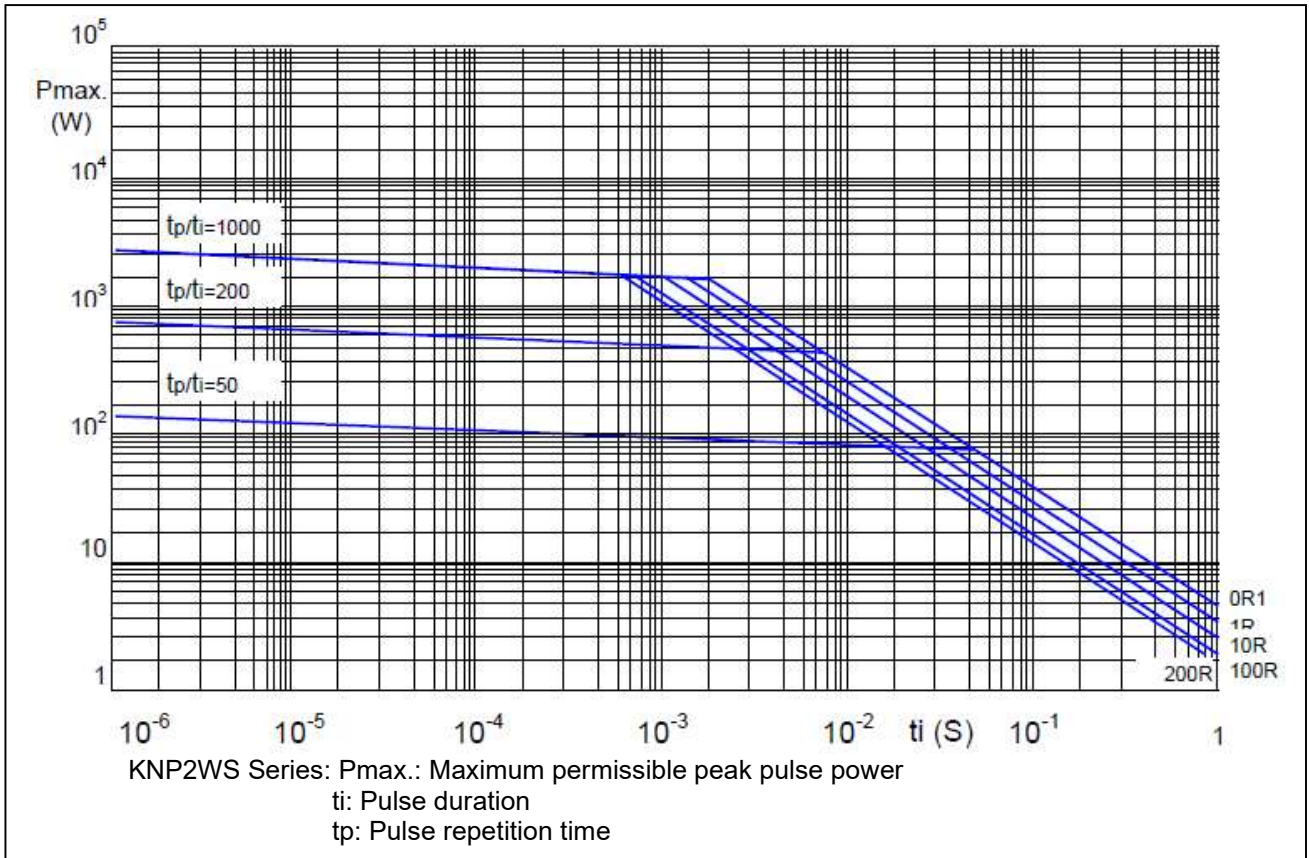

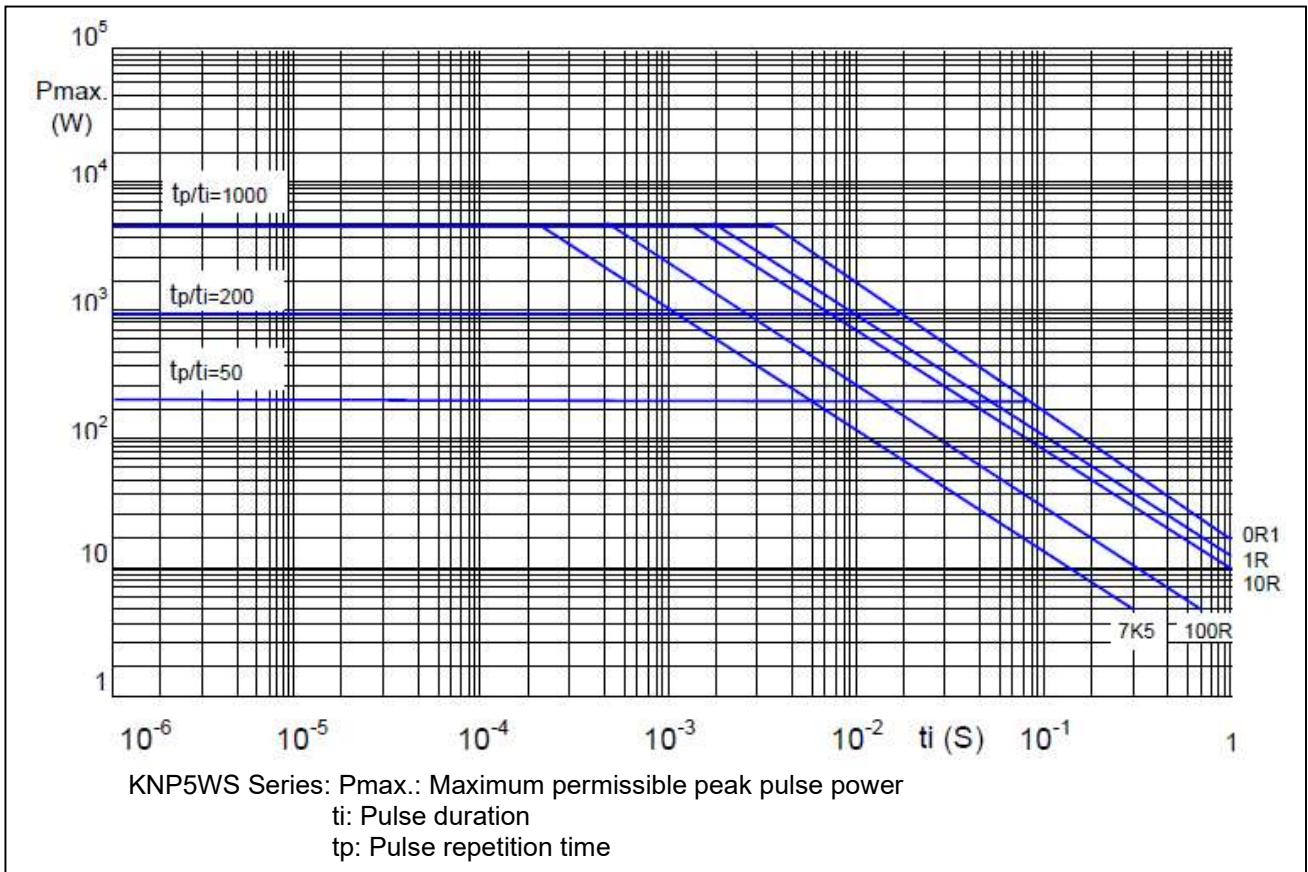
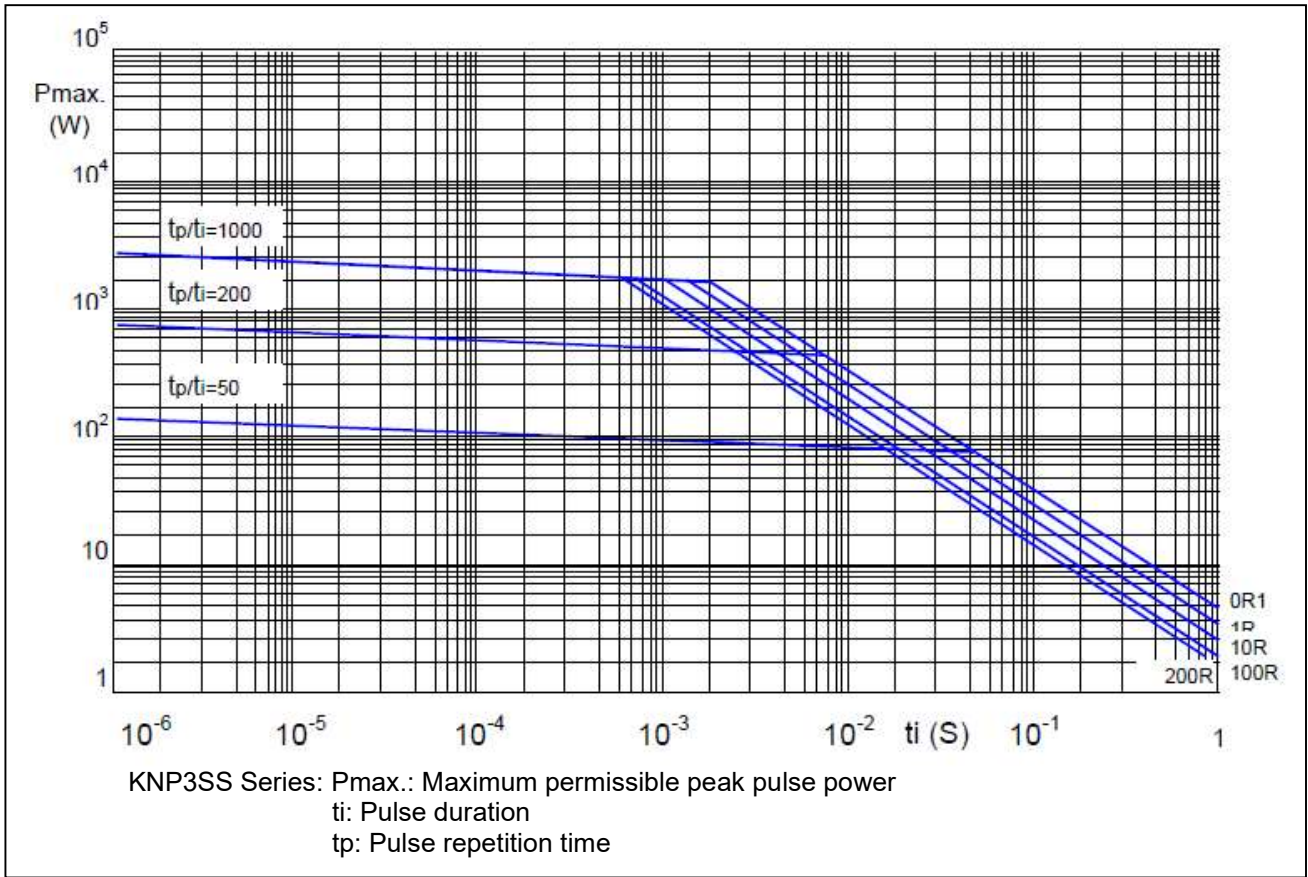

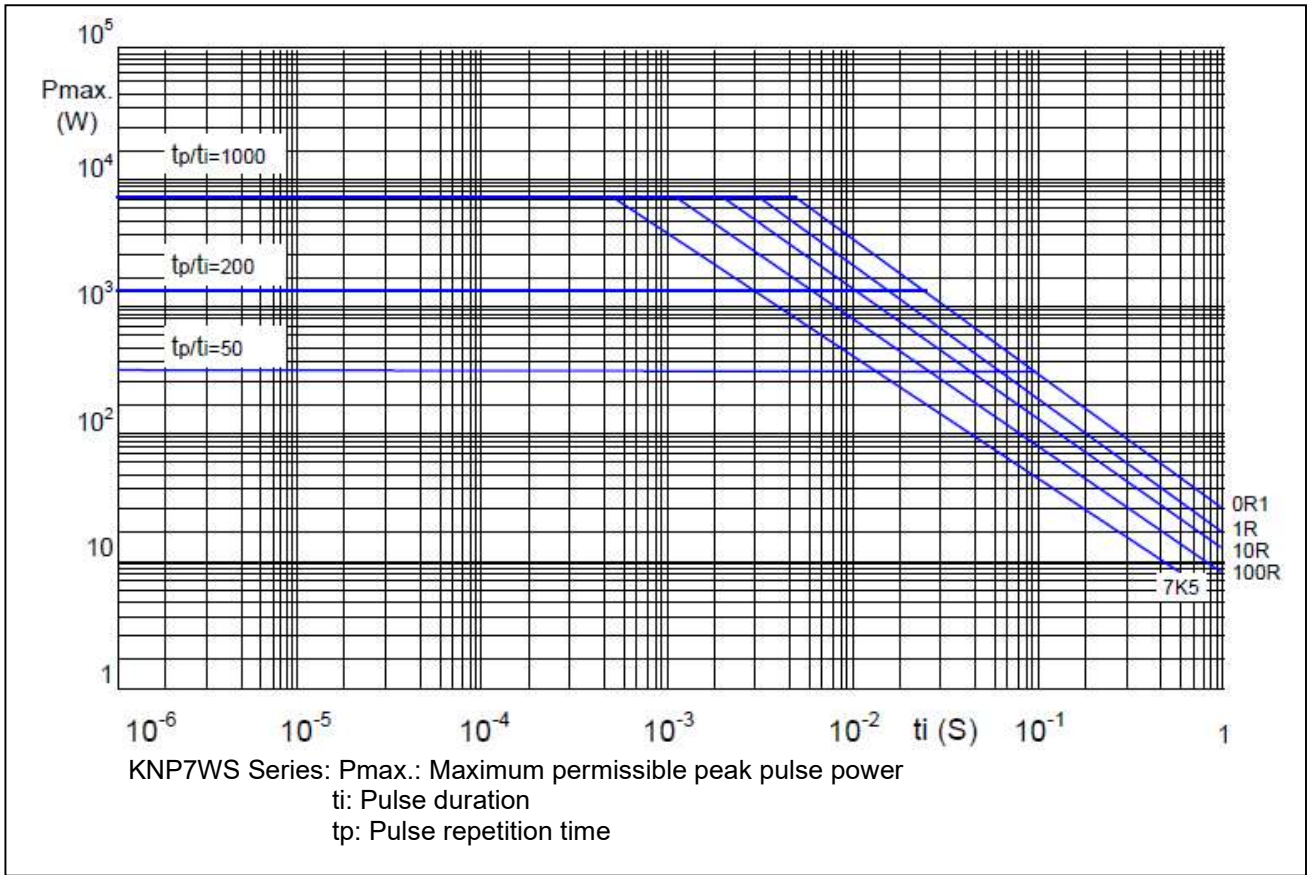

**AXIAL / REEL TAPE SPECIFICATION**

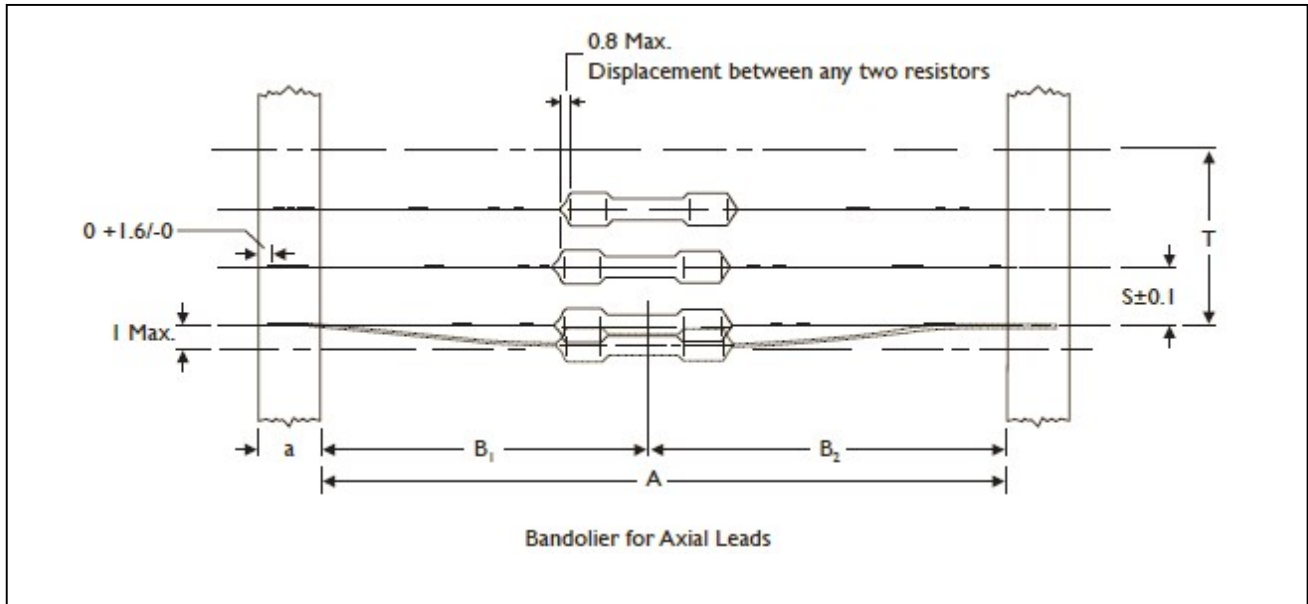

Unit: mm

Normal	Miniature	a	A	B1-B2 (Max.)	S (spacing)	T (max. deviation of spacing)
KNP-25	KNP50S	$6 \pm 0.5$	$52.4 \pm 1.5$ $26.0 \pm 1.5$	1.2 1.0	5	1 mm per 10 spacing, 0.5 mm per 5 spacing
KNP-50	KNP1WS	$6 \pm 0.5$	$52.4 \pm 1.5$	1.2	5	
KNP100	KNP2WS KNP3SS	$6 \pm 0.5$	$73.0 \pm 1.5$	1.5	5	
			$52.4 \pm 1.5$	1.2		
KNP200 KNP300 KNP400	KNP3WS KNP5WS	$6 \pm 0.5$	$73.0 \pm 1.5$	1.5	10	
			$52.4 \pm 1.5$	1.2		
KNP500 KNP600	KNP7WS	$6 \pm 0.5$	$91.0 \pm 1.5$	1.5	10	
KNP700	-	$6 \pm 0.5$	$91.0 \pm 1.5$	1.5	10	

**TAPE ON REEL PACKING**

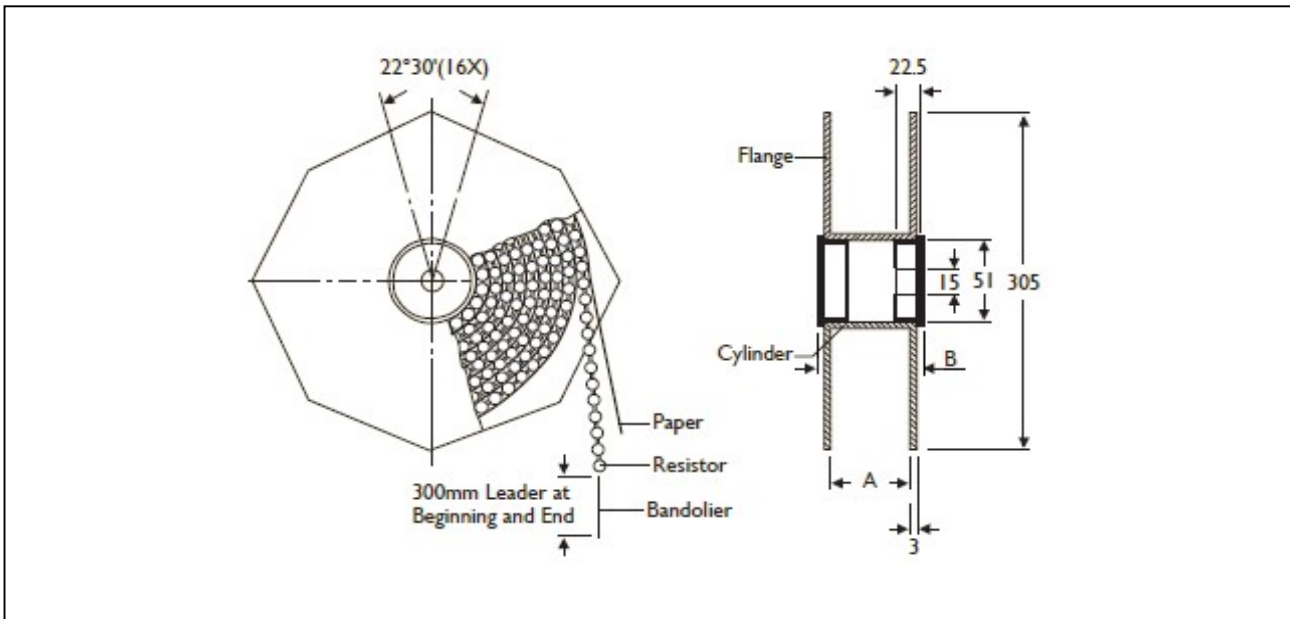

TYPE		Unit: mm/piece		
Normal	Miniature	Across Flange(A)	B	Quantity Per Reel
KNP-25	KNP50S	66.5	75.5	5,000
KNP-50	KNP1WS	66.5	75.5	2,500
KNP100	KNP2WS KNP3SS	87	96	2,000
KNP200	KNP3WS	87	96	1,000
KNP300 KNP400	KNP5WS	87	96	1,000

**TAPE ON BOX PACKING**

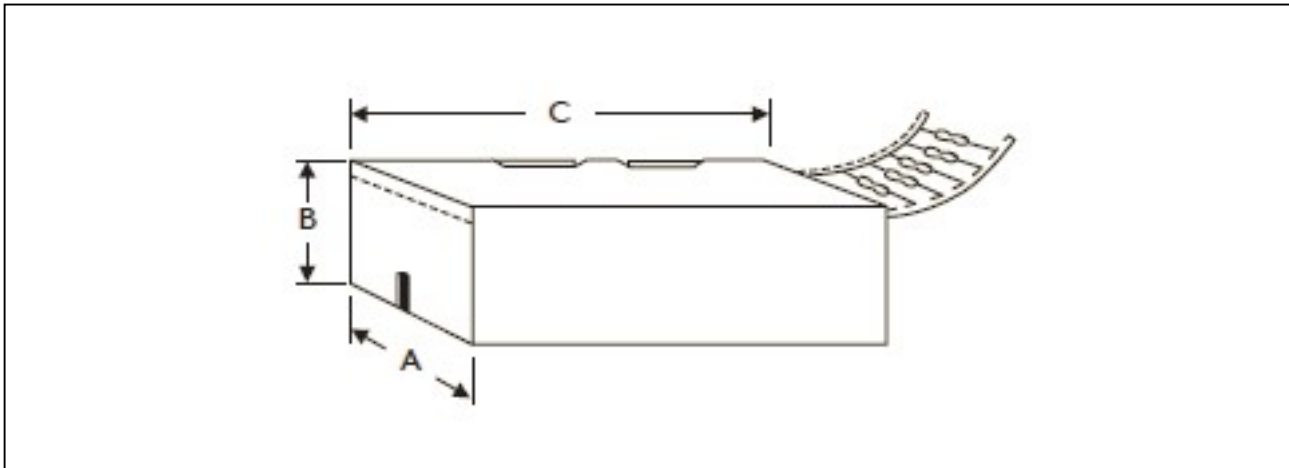

TYPE		DIMENSIONS			Unit: mm/piece
Normal	Miniature	A	B	C	Quantity Per Box
KNP-25	KNP50S	48	102	255	5,000
KNP-25	KNP50S	81	104	260	5,000
KNP-50	KNP1WS	73	45	258	1,000
KNP100	KNP2WS KNP3SS	81	91	260	1,000
KNP100	KNP2WS KNP3SS	103	78	260	1,000
KNP200	KNP3WS	81	91	260	1,000
KNP200	KNP3WS	103	94	260	1,000
KNP300 KNP400	KNP5WS	81	91	260	500
KNP300 KNP400	KNP5WS	103	78	260	500
KNP500 KNP600	KNP7WS	116	79	255	250
KNP700	-	116	79	255	250

**BULK PACKING**

Normal	Miniature	Piece/Per Inner Box	Bag/Per Inner Box	Piece Per Bag
KNP-25	KNP50S	10,000	10	1,000
KNP-50	KNP1WS	5,000	5	1,000
KNP100	KNP2WS KNP3SS	2,000	4	500
KNP200	KNP3WS	1,000	2	500
KNP300 KNP400	KNP5WS	1,000	2	500
KNP500 KNP600	KNP7WS	500	10	50
KNP700	-	500	10	50

**FORMING**

**M TYPE**

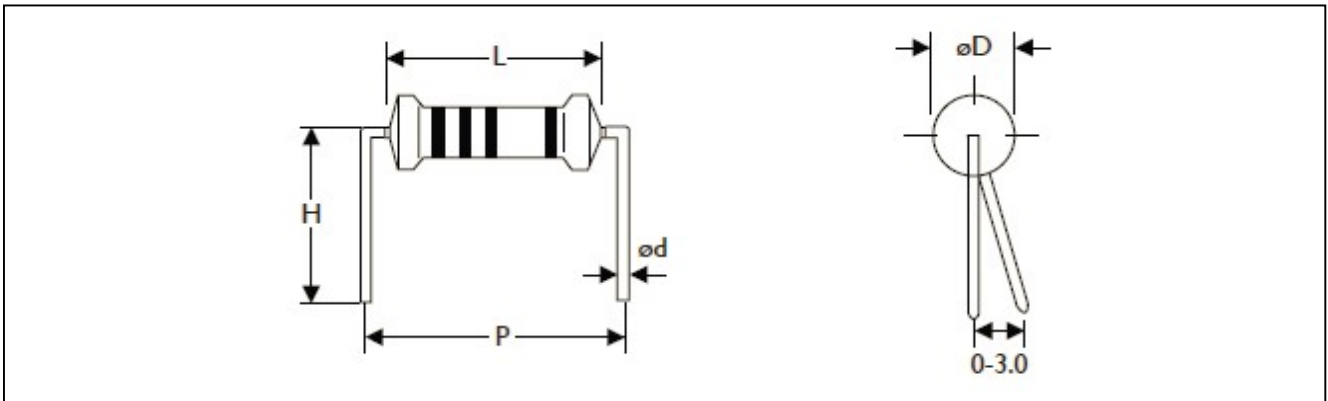

TYPE		DIMENSIONS					Unit: mm
Normal	Miniature	L	$\psi D$	$\psi d$	P	H	
KNP-25	KNP50S	$6.3 \pm 0.5$	$2.5 \pm 0.3$	$0.55 \pm 0.05$	$10.0 \pm 1$	$10.0 \pm 1$	
KNP-50	KNP1WS	$9.0 \pm 0.5$	$3.5 \pm 0.3$	$0.55 \pm 0.05$	$12.5 \pm 1$	$10.0 \pm 1$	
KNP100	KNP2WS KNP3SS	$11.5 \pm 1.0$	$4.6 \pm 0.5$	$0.8 \pm 0.05$	$15.0 \pm 1$	$12.5 \pm 1$	
KNP200	KNP3WS	$15.5 \pm 1.0$	$5.2 \pm 0.5$	$0.8 \pm 0.05$	$20.0 \pm 1$	$15.0 \pm 1$	
KNP300 KNP400	KNP5WS	$17.5 \pm 1.0$	$6.2 \pm 0.5$	$0.8 \pm 0.05$	$25.0 \pm 1$	$15.0 \pm 1$	
KNP500 KNP600	KNP7WS	$24.5 \pm 1.0$	$8.2 \pm 0.5$	$0.8 \pm 0.05$	$30.0 \pm 1$	$15.0 \pm 1$	

**MB TYPE**

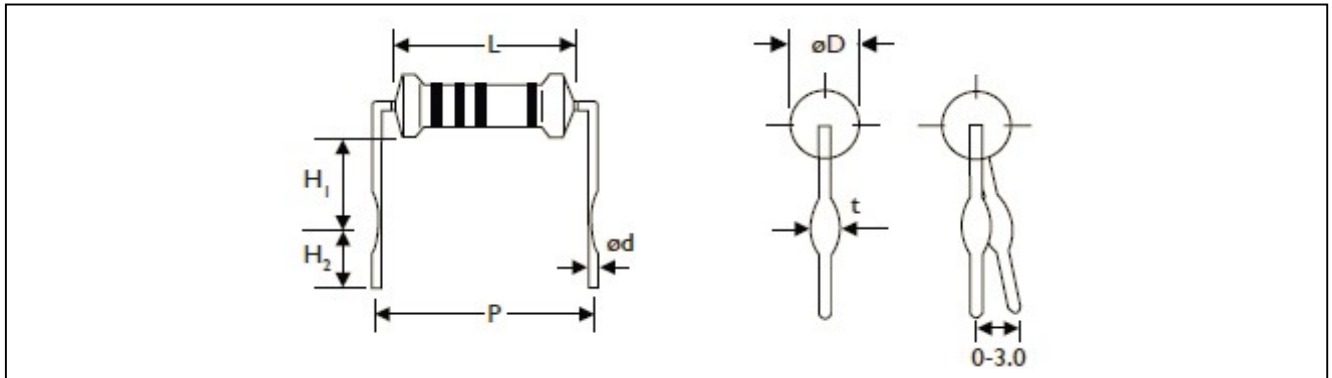

TYPE		DIMENSIONS							Unit: mm
Normal	Miniature	L	ψD	ψd	P	H1	H2	t	
KNP-25	KNP50S	6.3 ± 0.5	2.5 ± 0.3	0.55 ± 0.05	10.0 ± 1	6.0 ± 1	5.0 ± 1	1.2 ± 0.2	
KNP-50	-	9.0 ± 0.5	3.5 ± 0.3	0.55 ± 0.05	12.5 ± 1	6.0 ± 1	5.0 ± 1	1.2 ± 0.2	
-	KNP1WS	9.0 ± 0.5	3.5 ± 0.3	0.8 ± 0.05	12.5 ± 1	6.0 ± 1	5.0 ± 1	1.4 ± 0.2	
KNP100	KNP2WS KNP3SS	11.5 ± 1.0	4.6 ± 0.5	0.8 ± 0.05	15.0 ± 1	6.0 ± 1	5.0 ± 1	1.4 ± 0.2	
KNP200	KNP3WS	15.5 ± 1.0	5.2 ± 0.5	0.8 ± 0.05	20.0 ± 1	10.0 ± 1	5.0 ± 1	1.4 ± 0.2	
KNP300 KNP400	KNP5WS	17.5 ± 1.0	6.2 ± 0.5	0.8 ± 0.05	30.0 ± 1	15.0 ± 1	5.0 ± 1	1.4 ± 0.2	

**MHA TYPE**

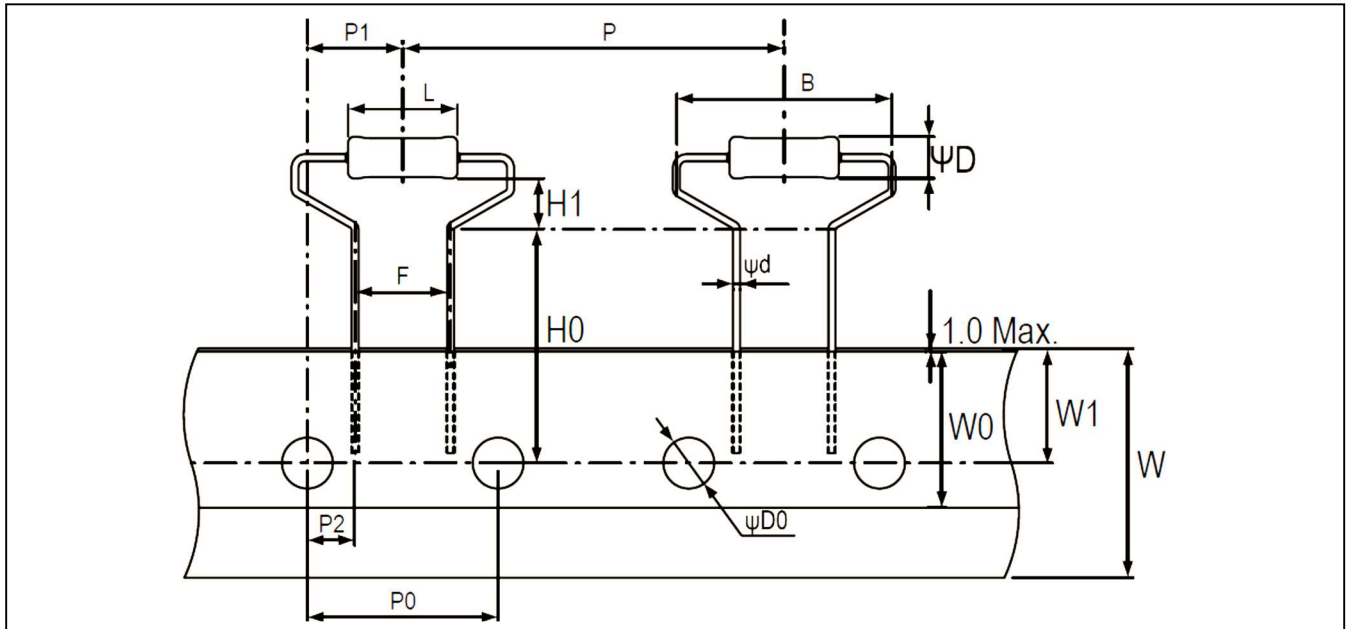

TYPE		DIMENSIONS								Unit: mm
Normal	Miniature	L	ψD	ψd	B	H0	H1	P	P0	
		9.0±0.5	3.5±0.3	0.55±0.05	17.5Max	19.0±1.0	4.0±1.0	30.0±1.0	15.0±0.3	
KNP-50	KNP1WS	<b>P1</b>	<b>P2</b>	<b>F</b>	<b>W</b>	<b>W0</b>	<b>W1</b>	<b>ψD0</b>		
		7.5±1.0	3.75±0.5	7.5±0.5	18.0±0.5	5.0Min	9.0±0.5	4.0±0.2		

**MHB TYPE**

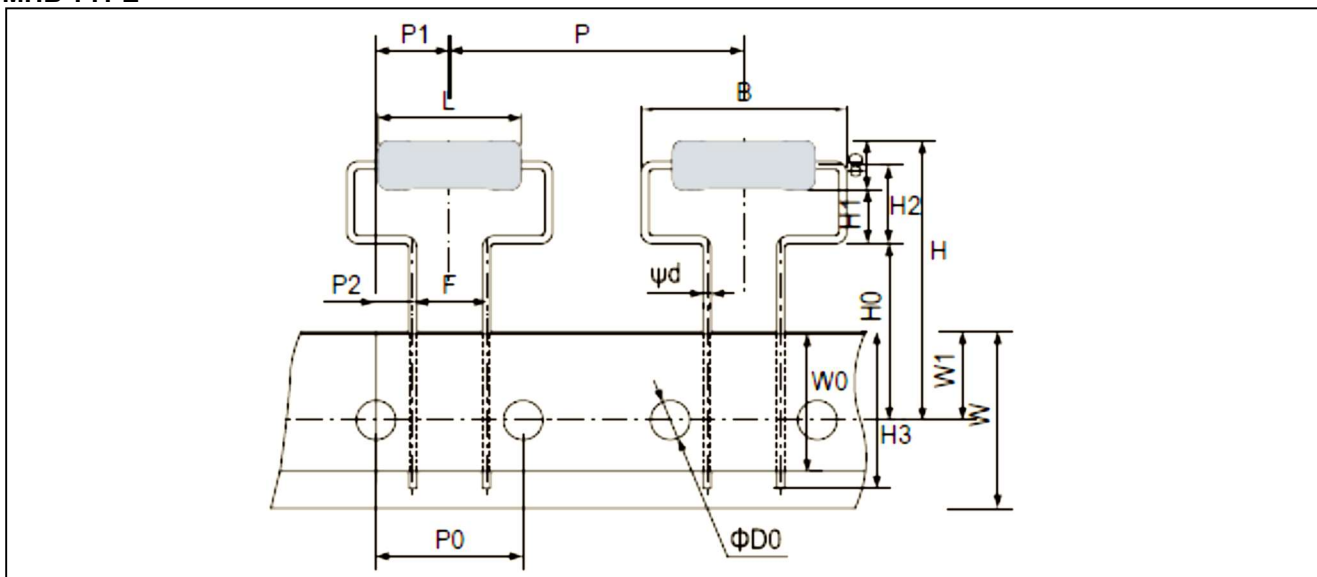

TYPE		DIMENSIONS									Unit: mm
<b>Normal</b>	<b>Miniature</b>	<b>L</b>	<b>ψD</b>	<b>ψd</b>	<b>B</b>	<b>H</b>	<b>H0</b>	<b>H1</b>	<b>H2</b>	<b>H3</b>	
		15.5±1.0	5.2±0.5	0.8±0.05	21.0Max.	30Max.	18.0±1.0	5.5(Ref.)	8.0±1.5	16Max.	
<b>KNP200</b>	<b>KNP3WS</b>	<b>P</b>	<b>P0</b>	<b>P1</b>	<b>P2</b>	<b>F</b>	<b>W</b>	<b>W0</b>	<b>W1</b>	<b>ψD0</b>	
		30.0±1.0	15.0±0.3	7.5±1.0	3.75±0.8	7.5±0.5	18.0±0.5	5.0Min.	9.0±0.5	4.0±0.3	

**MHC TYPE**

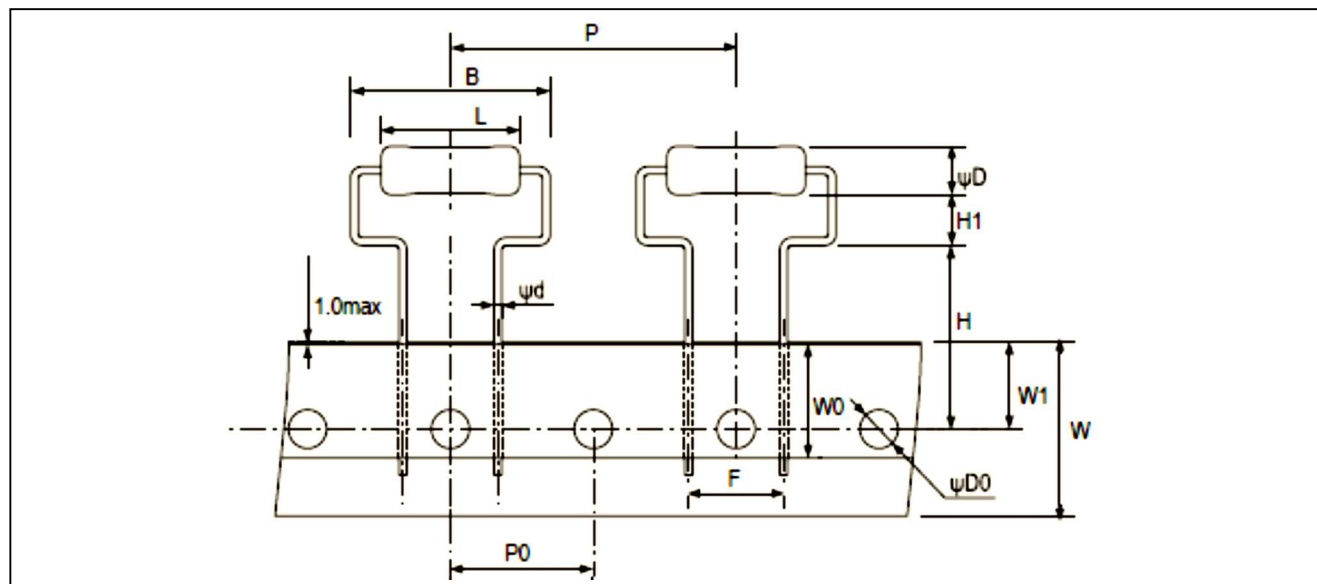

TYPE		DIMENSIONS								Unit: mm
<b>Normal</b>	<b>Miniature</b>	<b>L</b>	<b>ψD</b>	<b>ψd</b>	<b>B</b>	<b>H</b>	<b>H1</b>	<b>P</b>	<b>P0</b>	
		15.5±1.0	5.2±0.5	0.8±0.05	21.0Max.	19.0±1.0	5.25±1.0	30.0±1.0	15.0±0.3	
<b>KNP200</b>	<b>KNP3WS</b>	<b>F</b>	<b>W</b>	<b>W0</b>	<b>W1</b>	<b>ψD0</b>				
		10.0±0.5	18.0±0.5	5.0Min.	9.0±0.5	4.0±0.2				

**F TYPE**

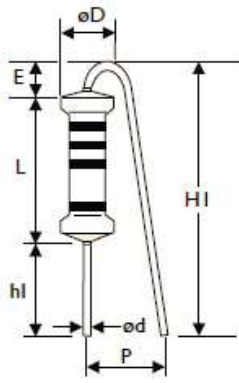

**FK TYPE**

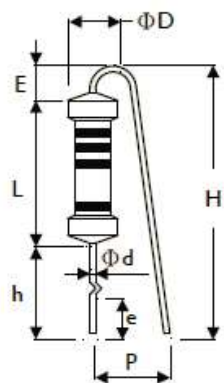

**FFK TYPE**

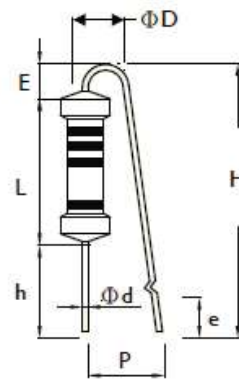

**FKK TYPE**

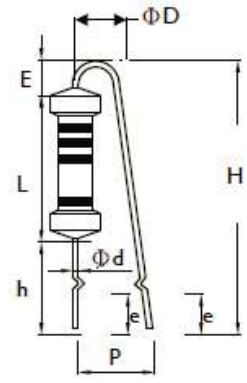

TYPE		DIMENSIONS										Unit: mm
Normal	Miniature	L	ψD	ψd	P	h	H Max.	hl	Hl Max.	E Max.	e	
KNP-50	KNP1WS	9.0±0.5	3.5±0.3	0.55±0.05	6±1	8±1	22	5±1	18.5	3.5	3.5±1	
KNP100	KNP2WS	11.5±1	4.6±0.5	0.8±0.05	6±1	8±1	24	5±1	20	3.5	3.5±1	
KNP200	KNP3WS	15.5±1	5.2±0.5	0.8±0.05	8±1	8±1	28	5±1	25	3.5	3.5±1	

**PN TYPE (Taping Pack)**

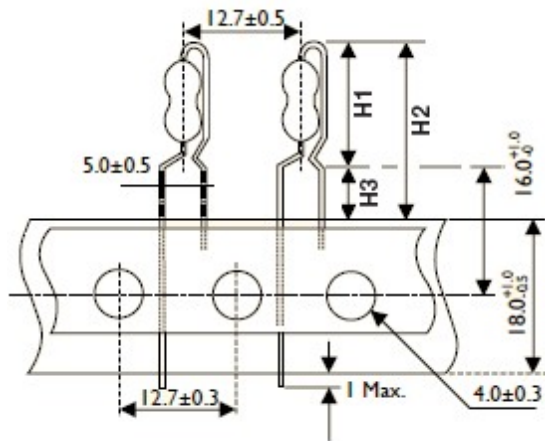

**AV TYPE (Taping Pac)**

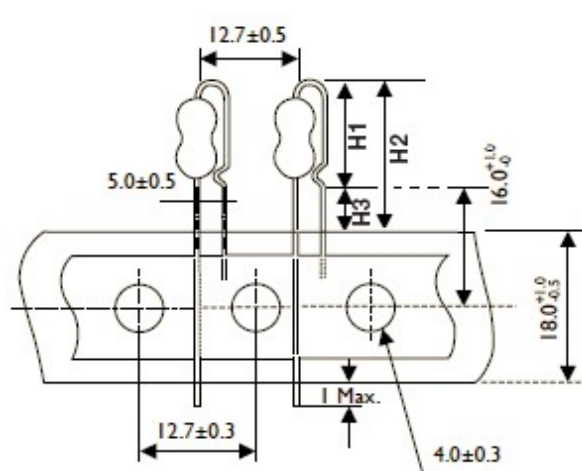

TYPE		DIMENSIONS			Unit: mm
Normal	Miniature	H1 Max.	H2 Max.	H3 Max.	
KNP-25	KNP50S	13	21.5	8.5	
KNP-50	KNP1WS	17	25.5	8.5	
KNP100	KNP2WS KNP3SS	19	27.5	8.5	

TYPE		DIMENSIONS			Unit: mm
Normal	Miniature	H1 Max.	H2 Max.	H3 Max.	
KNP-25	KNP50S	11.5	20	8.5	
KNP-50	KNP1WS	14.5	23	8.5	
KNP100	KNP2WS KNP3SS	17.5	26	8.5	

**FT TYPE (Taping Pack)**

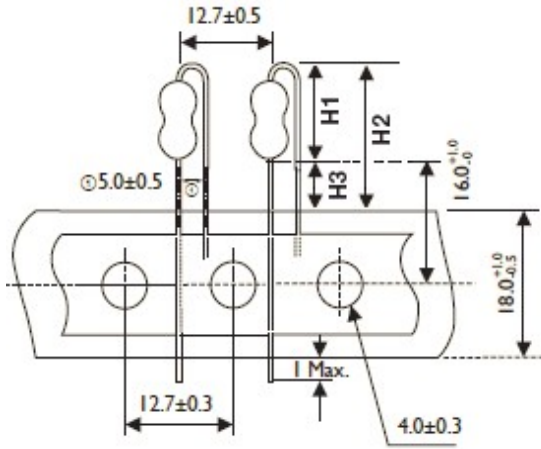

TYPE		DIMENSIONS			Unit: mm
Normal	Miniature	H1 Max.	H2 Max.	H3 Max.	
KNP-25	KNP50S	10	18.5	8.5	
KNP-50	KNP1WS	13	21.5	8.5	
KNP100	KNP2WS KNP3SS	16	24.5	8.5	

**MARKING**

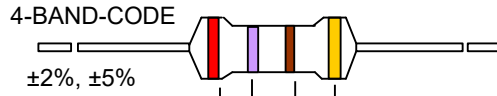

COLOR	1st BAND	2nd BAND	3rd BAND	MULTIPLIER	TOLERANCE
BLACK	0	0	0	1Ω	
BROWN	1	1	1	10Ω	± 1% ( F )
RED	2	2	2	100Ω	± 2% ( G )
ORANGE	3	3	3	1KΩ	
YELLOW	4	4	4	10KΩ	
GREEN	5	5	5	100K	
BLUE	6	6	6	1MΩ	
VIOLET	7	7	7	10MΩ	
GREY	8	8	8	0.001Ω	
WHITE	9	9	9	0.0001Ω	
GOLD				0.1Ω	± 5% ( J )
SILVER				0.01Ω	

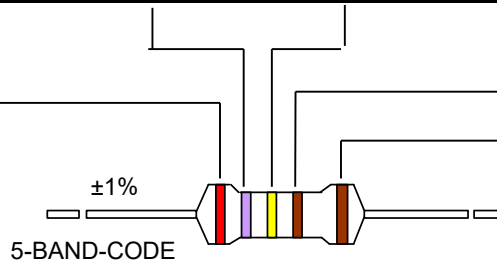

**REVISION HISTORY**

REVISION	DATE	CHANGE NOTIFICATION	DESCRIPTION
Version 3	Nov. 10, 2023	-	- Delete MB type for KNP500&KNP600&KNP7WS
Version 2	Aug. 31, 2023	-	- Revised LEGAL DISCLAIMER
Version 1	Jun. 10, 2022	-	Add suffix code to part number
Version 0	Aug. 2, 2021	-	- First issue of this specification

*“ Yageo reserves all the rights for revising the content of this datasheet without further notification, as long as the products itse If are unchanged. Any product change will be announced by PCN.”*

## LEGAL DISCLAIMER

YAGEO, its distributors and agents (collectively, "YAGEO"), hereby disclaims any and all liabilities for any errors, inaccuracies or incompleteness contained in any product related information, including but not limited to product specifications, datasheets, pictures and/or graphics. YAGEO may make changes, modifications and/or improvements to product related information at any time and without notice.

YAGEO makes no representation, warranty, and/or guarantee about the fitness of its products for any particular purpose or the continuing production of any of its products. To the maximum extent permitted by law, YAGEO disclaims (i) any and all liability arising out of the application or use of any YAGEO product, (ii) any and all liability, including without limitation special, consequential or incidental damages, and (iii) any and all implied warranties, including warranties of fitness for a particular purpose, non -infringement and merchantability.

YAGEO products are designed for general purpose applications under normal operation and usage conditions. Please contact YAGEO for the applications listed below which require especially high reliability for the prevention of defects which might directly cause damage to the third party's life, body or property: Aerospace equipment (artificial satellite, rocket, etc.), Atomic energy-related equipment, Aviation equipment, Disaster prevention equipment, crime prevention equipment, Electric heating apparatus, burning equipment, Highly public information network equipment, data-processing equipment, Medical devices, Military equipment, Power generation control equipment, Safety equipment, Traffic signal equipment, Transportation equipment and Undersea equipment, or for any other application or use in which the failure of YAGEO products could result in personal injury or death, or serious property damage. Particularly **YAGEO Corporation and its affiliates do not recommend the use of commercial or automotive grade products for high reliability applications or manned space flight.**

Information provided here is intended to indicate product specifications only. YAGEO reserves all the rights for revising this content without further notification, as long as products are unchanged. Any product change will be announced by PCN.